

Technika pomiarowa

Diagnostic systems



HYDRO

hydro.pl



Sektory które **zaopatrujemy**



Szeroka oferta prosto z magazynu

- ▶ Przewody hydrauliczne i przemysłowe
- ▶ Cylindry hydrauliczne
- ▶ Zasilacze hydrauliczne
- ▶ Zawory
- ▶ Elementy złączne
- ▶ Pręty i rury
- ▶ Technika filtracyjna
- ▶ Pompy
- ▶ Elementy do produkcji cylindrów hydraulicznych
- ▶ Układy hydrauliczne
- ▶ Rozdzielacze
- ▶ Agregaty filtracyjne
- ▶ Technika pomiarowa
- ▶ Elementy zasilaczy i układów hydraulicznych
- ▶ Silniki hydrauliczne
- ▶ Elementy do produkcji przewodów
- ▶ Urządzenia do produkcji przewodów
- ▶ Technika napędowa
- ▶ Chemia przemysłowa



„Lepiej zapobiegać niż leczyć”

Filozofia firmy Mini Press

Firma Mini Press, w przeciągu szesnastu lat swojej działalności stała się jednym z największych i najbardziej wykwalifikowanych producentów hydraulicznych systemów pomiarowych. Zawdzięcza to ciężkiej pracy, ciągłemu udoskonalaniu swojego systemu pomiarowego, oraz współpracą ze znaczącymi firmami produkcyjnymi. Opracowany przez Mini Press system pomiarowy, zapewnia skuteczność, bezpieczeństwo i wytrzymałość we wszystkich maszynach, w których jest zamontowany.

Firma Mini Press kieruje się zasadą „zawsze lepiej jest zapobiegać niż leczyć” oznacza to, że zarówno ich produkty oraz metody badania pozwalają uniknąć przyszłych uszkodzeń i drogich napraw, jednocześnie zwiększając jakość i wydajność Państwa maszyn.

“Prevention is better than cure”

The Mini Press philosophy

Mini Press during sixteen years of activity, has been able to establish itself as one of the major and most qualified producers of hydraulic testing equipment in the world. All of this was achieved through hard work at refining and improving its testing system, and by catching the attention and finding favor with the most attentive and significant manufacturing companies. Mini Press testing method, devised in-house, guarantees efficiency, safety and endurance for all the machines to which it is installed at construction.

The Mini Press is believed that prevention is always better than cure, Mini Press products and diagnostic testing method are excellent for avoiding any future malfunctioning and expensive repairs and at the same time they can increase the quality and the performance of your machines.

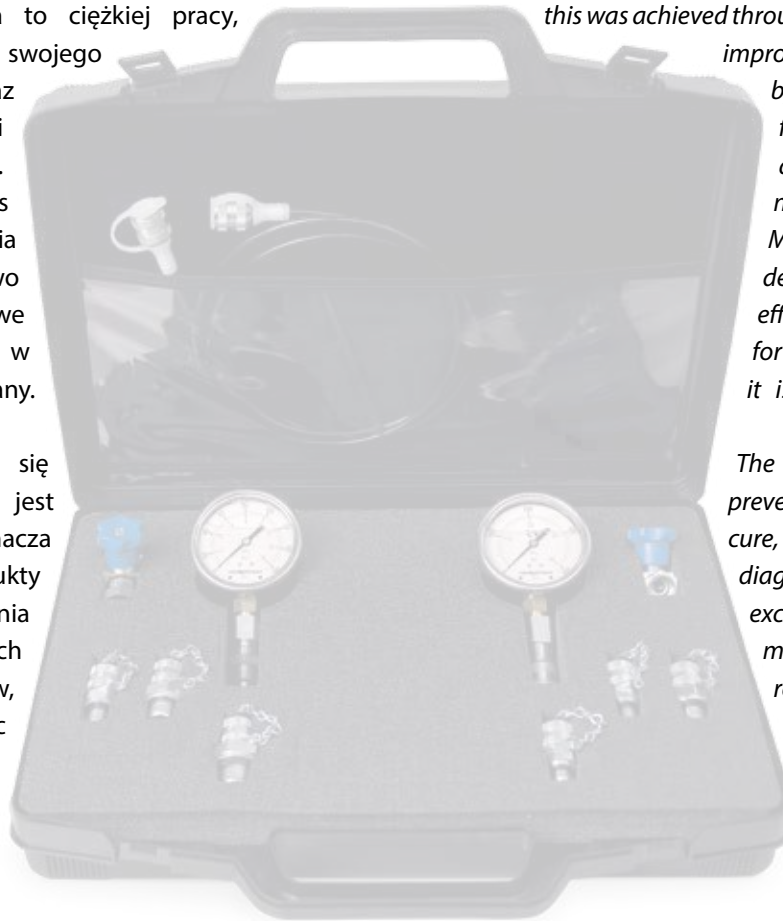

Jakość oraz skuteczność w każdej aplikacji

Produkty i systemy firmy Mini Press mogą być stosowane w każdym rodzaju maszyn czy urządzeniach, we wszystkich sektorach przemysłu: rolnictwa, budownictwa, transportu, itd. Zastosowanie ich podnosi bezpieczeństwo i jakość Państwa produktów, tym bardziej gdy charakteryzują się one świetnym współczynnikiem kosztów do korzyści.

Mini Press stworzył i opracował tzw.: „Rapid System”, czyli pełną gamę zminiaturyzowanych produktów pozwalających na ciągłe monitorowanie i natychmiastową kontrolę każdego

urządzenia hydraulicznego. Należy pamiętać, że zlokalizowanie problemu jest bardzo ważne, gdyż pozwala uniknąć przyszłych komplikacji. „Rapid System” może być

zastosowany podczas pracy urządzenia bez konieczności jej wyłączania. Dzięki temu zaoszczędzamy czas i środki przeznaczone do obsługi maszyn, oraz zapewniamy bezpieczeństwo jej operatorowi. „Rapid System” jest jedynym rozwiązaniem, które pozwala efektywnie monitorować instalacje hydrauliczne, a przy okazji zwiększa wartość urządzenia. Dzięki know-how i doświadczeniu firma Mini Press jest partnerem, na którym zawsze można polegać.



Quality, efficiency and application

Mini Press products and systems can be applied to any type of mobile machine in all the main sectors: agricultural, industrial, building construction or transport and in each sector the manufacturer can increase the quality and safety of their machines, thanks to the amazing cost/benefits ratio of our products.

Mini Press created and finely tuned “Rapid System”, a complete range of miniaturized components which allow a constant monitoring and immediate control on any hydraulic equipment. By localizing immediately any problem in the system it avoids any further complications. “Rapid system” can be used at any time during the phases of testing, bleeding, fluid sampling, maintenance and assistance, without stopping the functioning of the plant. Thus reducing the amount of time and resources spent on servicing the machines, and at the same time further insures the operators’ safety. “Rapid system” is the only solution that enables a reliable and effective control of hydraulics plants and at the same time increases the intrinsic value of the machine to which it is installed. With all its experience and know-how Mini Press is a true business partner, on whom one can always rely on.





Elementy złączne do pomiarów ciśnienia
Test couplings for pressure checking

strona / page 2

1



Elementy do produkcji przewodów pomiarowych
Micro hose for high pressure and fittings

strona / page 16

2



Przenośne zestawy pomiarowe
Portable hydraulic instruments for pressure testing

strona / page 35

3



Manometry ciśnieniowe
Pressure gauges

strona / page 36

4



Akcesoria
Accessory

strona / page 43

5



Zakuwarka ręczna do przewodów pomiarowych i klimatyzacji
Crimping Machine for microhoses and hoses for A/C&R

strona / page 44

6



1

Zastosowanie:

- Kontrola ciśnienia
- Smarowanie
- Odpowietrzanie
- Testowanie oleju

Materiał:

Galwanizowana stal
(Stal nierdzewna AISI 316 dostępna na życzenie)

Uszczelnienie:

(NBR)
FKM – VITON (na życzenie)

Temperatura pracy:

-30°C...+125°C (NBR)
-25°C...+230°C (FKM)

Ciecze:

- Oleje hydrauliczne
- Oleje mineralne
- Możliwość dostosowania do innych cieczy

Applications:

- Pressure control
- Lubrication
- Air breathing
- Oil sampling

Materials:

Galvanised carbon steel
(Stainless steel AISI 316 is available on request)

Sealing:

NITRILE BUNA N (NBR)
FKM – VITON (on request)

Working temperature:

-30°C...+125°C (NITRILE BUNA N)
-25°C...+230°C (FKM)

Fluids:

- Hydraulic oils
- Mineral oils
- Suitability with other fluids on request

Rodzaje uszczelnień stosowanych w przyłączach pomiarowych

Hole screw-cuts and sealing types

Typ A

Uszczelnienie O-Ring
O-Ring sealing

	G	D	L	H
M8x1		9,5	11	15,5
M10x1		11,5	12	16,5
M10x1,25		11	12	16,5
M14x1,5		15,8	12	18

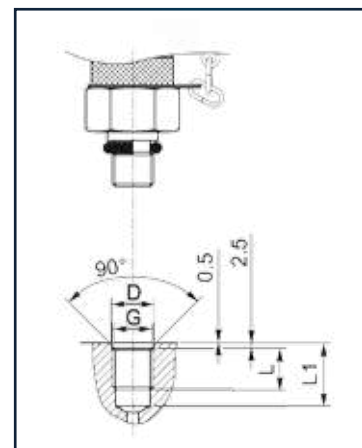

Typ B

Podkładka metalowo-gumowa
Metal sealing edge

	G	D	L	L1	S
M10x1		15	10	13,5	1
M12x1,5		18	12	18,5	1
M14x1,5		20	14	18,5	1
M16x1,5		22	14	18,5	1,5
ISO 228 G 1/8"		15	10	13,5	1
ISO 228 G 1/4"		19	14	18,5	1
ISO 228 G 3/8"		24	16	18,5	1,5

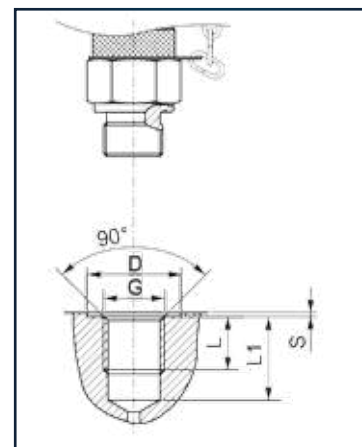

Typ C

Uszczelnienie elastomerowe płaskie
Flat gasket sealing

G	D	L	L1	S
M10x1	17	10	13,5	1
M12x1,5	18	12	18,5	1
M14x1,5	20	14	18,5	1
M16x1,5	22	14	18,5	1,5
ISO 228 G 1/8"	17	10	13,5	1
ISO 228 G 1/4"	20	14	18,5	1
ISO 228 G 3/8"	24	16	18,5	1,5
ISO 228 G 1/2"	30	18	24	1,5

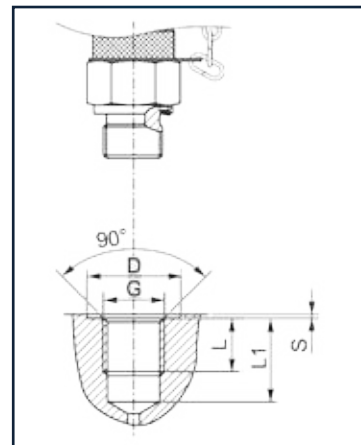

1

Typ D

Uszczelnienie na gwincie:
- BSPT
- NPTF

Sealing by thread:
- B.S.P. Taper ISO 7/1
- Taper NPTF

G	L	L1
ISO 7/1 1/8"	5,5	12
ISO 7/1 1/4"	8,5	13,5
ISO 7/1 3/8"	12	20
1/8"-27 NPTF	9	14
1/4"-18 NPTF	9	18,5
3/8"-18 NPTF	14	20

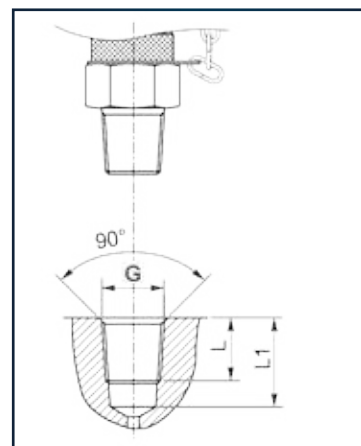

Typ E

Uszczelnienie O-Ring wg normy UNF
UNF O-Ring sealing

G	d	D	L	L1	S	a
7/16"-20 UNF	12,41	17	11,50	14	2,40	1,60
1/2"-20 UNF	14	18	11,50	14	2,40	1,60
9/16"-18 UNF	15,60	20	12,70	15,50	2,50	1,60
3/4"-16 UNF	20,50	25	16	20	2,60	2,40

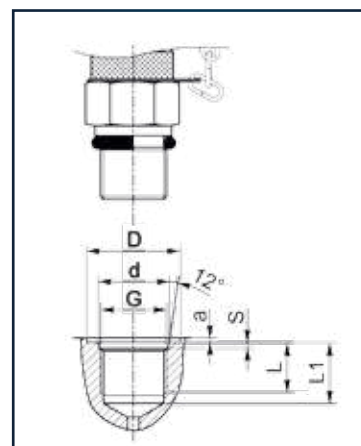

Sposób zamawiania

How to order

1

Proszę podać kod w wymaganym miejscu w formularzu i dodać literę wybranej opcji, jeśli jest to konieczne.

Please indicate the code shown in the required form chart, and add, if necessary, the letter of the chosen option.

Konfiguracja / Form

Metalowa zatyczka z łańcuszkiem i z zaworem kulowym
Metal cap with chain and ball sealing system

Kod bez „S1” / Delete “S1” in the ref. xxxxxxxC

Kod z „C” / “C” in the ref. xxxxxxxC

Metalowa zatyczka z łańcuszkiem i z zaworem grzybkowym
Metal cap with chain and poppet valve sealing system

Kod z „S1” / Put „S1” in the ref. S1xxxxxxxC

Kod z „C” / “C” in the ref. S1xxxxxxxC

Opcje / Options

Metalowa zatyczka z plastikowym zaczepem
Metal cap with plastic binder

O Zamień „C” na „O” / Replace “C” with “O” xxxxxxxO

Plastikowa zatyczka
Plastic cap

P Zamień „C” na „P” / Replace “C” with “P” xxxxxxxP



Przyłącze pomiarowe M16x2

Threaded test couplings M16x2

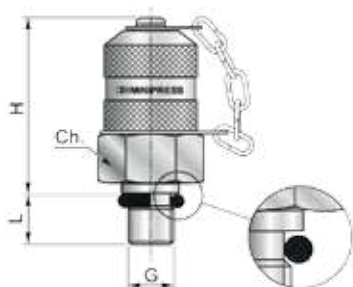

Kod / Code	G	H	L	Ch	PN [bar]	Uszczelka / Seal
Przyłącze metryczne / Metric parallel						
S10108X10C	M8x1	37	8,5	17	250	O-Ring Typ A
S10110X10C	M10x1	37	8,5	17	630	
S10110X12C	M10x1,25	37	9	17	630	
S10114X15C	M14x1,5	37	10	19	630	
Przyłącze UNF / Metric parallel						
S10171X20C	7/16"-20UNF	37	9	17	630	O-Ring Typ B
S10112X20C	1/2"-20UNF	37	10	17	630	
S10191X18C	9/16"-18UNF	37	10	19	630	
S10134X16C	3/4"-16UNF	37	14	22	630	
S10151X24C	5/16"-24UNF	37	9	17	630	

Opcje / Options

O **P**

Przyłącze pomiarowe M16x2

Threaded test couplings M16x2

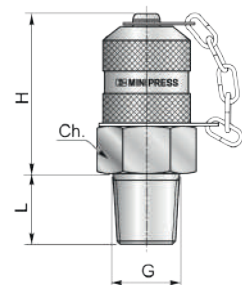
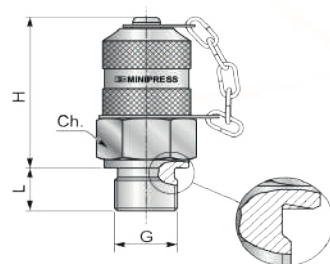
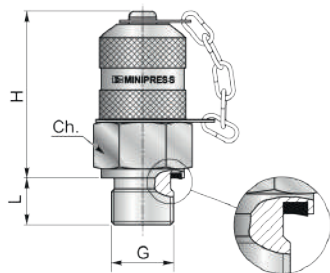

M16x2

Kod / Code	G	H	L	Ch	PN [bar]	Uszczelka / Seal
Przyłącze metryczne / Metric parallel						
S10410X10C	M10x1	37	8	17	630	Typ C
S10410X12C	M10x1,25	37	8	17	630	
S10612X15C	M12x1,5	37	10	17	630	
S10614X15C	M14x1,5	37	12	19	630	
S10614X15AIC	M14x1,5*	37	12	22	630	
S10616X15C	M16x1,5	37	12	22	630	
Przyłącze calowe / B.S.P. parallel						
S10718G00C	ISO 228 G 1/8"	37	8	17	630	Typ C
S10718GAIC	ISO 228 G 1/8"*	37	8	17	630	
S10714G00C	ISO 228 G 1/4"	37	12	19	630	
S10714GAIC	ISO 228 G 1/4"*	37	12	19	630	
S10738G00C	ISO 228 G 3/8"	37	14	22	630	
S10712G00C	ISO 228 G 1/2"	37	15	27	630	

*Stal nierdzewna / Stainless steel

Opcje / Options

O P

Kod / Code	G	H	L	Ch	PN [bar]	Uszczelka / Seal
Przyłącze metryczne / Metric parallel						
S10310X10C	M10x1	37	8,5	17	400	Typ B
S10312X15C	M12x1,5	37	12	17	630	
S10314X15C	M14x1,5	37	12	19	630	
S10316X15C	M16x1,5	37	12	22	630	
S10318X15C	M18x1,5	37	12	27	630	
S10320X15C	M20x1,5	37	12	27	630	
S10322X15C	M22x1,5	37	14	27	630	
S10327X15C	M27x1,5	37	16	32	630	
Przyłącze calowe / B.S.P. parallel - Form B						
S10418G00C	ISO 228 G 1/8"	37	8	17	400	Typ B
S10414G00C	ISO 228 G 1/4"	37	12	19	630	
S10438G00C	ISO 228 G 3/8"	37	14	22	630	
S10434G00C	ISO 228 G 3/4"	37	12	32	630	
S10412G00C	ISO 228 G 1/2"	37	14	27	630	

Opcje / Options

O P

Kod / Code	G	H	L	Ch	PN [bar]	Uszczelka / Seal
Przyłącze calowe BSPT / B.S.P. taper						
S10818280C	ISO 7/1 R 1/8"	37	10	17	400	Typ D
S10814190C	ISO 7/1 R 1/4"	37	12	19	630	
S1081419AIC	ISO 7/1 R 1/4"	37	12	19	630	
S10838190C	ISO 7/1 R 3/8"	37	14	22	630	
Przyłącze calowe NPTF / NPTF						
S10918270C	1/8"-27 NPTF	37	10	17	400	Typ D
S10914180C	1/4"-18 NPTF	37	17	19	630	
S1091418AIC	1/4"-18 NPT*	37	17	19	630	
S10938180C	3/8"-18 NPTF	37	16	22	630	
S10912140C	1/2"-14 NPTF	37	17	24	630	
S10914150C	1/4"-18 NPTF	37	14	17	630	

*Stal nierdzewna / Stainless steel

Opcje / Options

O P

Przyłącze pomiarowe M16x1,5

Threaded test couplings M16x1,5

1

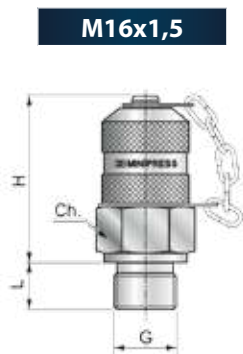

M16x1,5

Kod / Code	G	H	L	Ch	PN [bar]	Uszczelka / Seal
Przyłącze metryczne / Metric parallel						
S10108150C	M8x1	37	8,5	17	250	Typ A
S10110150C	M10x1	37	8,5	17	630	
Przyłącze calowe / B.S.P. Parallel						
S10714150C	ISO 228 G 1/4"	37	12	19	630	Typ C
S10718150C	ISO 228 G 1/8"	37	8	17	630	
S10614150C	M14x1,5	37	12	19	630	

Przyłącze pomiarowe S12,65x1,65

Threaded test couplings S12,65x1,65

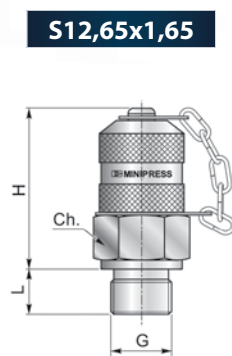

S12,65x1,65

Kod / Code	G	H	L	Ch	PN [bar]	Uszczelka / Seal
Przyłącze metryczne / Metric parallel						
S10108120C	M8x1	30	8,5	14	250	Typ A
S10110120C	M10x1	30	8,5	14	630	
Przyłącze calowe / B.S.P. parallel						
S10714120C	ISO 228 G 1/4"	29	8	19	630	Typ C
S10410X10120C	M10x1	37	8	17	630	
S10718120C	ISO 228 G 1/8"	37	8	17	630	

Przylącze pomiarowe

Threaded test couplings



Kod / Code	D	H	L	Ch	PN [bar]	
					L	S
S11206000C	6	37	20	17	315	630
S11206A100	6*	37	20	17	315	630
S11208000C	8	37	20	17	315	630
S11210000C	10	37	20	17	315	630
S11212000C	12	37	20	17	315	630
S11214000C	14	37	20	17	-	630
S11215000C	15	37	20	17	315	-
S11216000C	16	37	20	17	-	400

*Stal nierdzewna/ Stainless steel

Opcje / Options

O P

Złącze pomiarowe grodziowe

Bulkhead test coupling

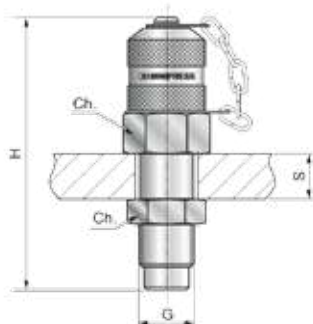

Kod / Code	G	H	Ch	S max	PN [bar]
S122PP000C	M16x2	80	19	25	630

Opcje / Options

O P

Złącze pomiarowe M16x2 z wyjściem grodziowym metrycznym

Bulkhead test coupling for metal pipe fitting

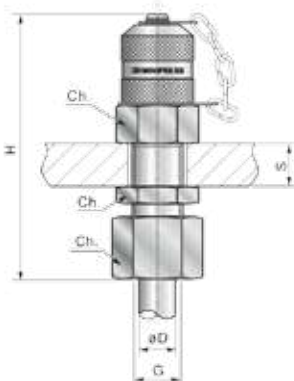

Kod / Code	Seria / Series	D	G	H	Ch	Ch1	S max	PN [bar]
S11616X15C	S	8	M16x1,5	80	19	19	20	630
S11618X15C		10	M18x1,5	82	22	22	20	630
S11620X15C		12	M20x1,5	84	24	24	20	630

Opcje / Options

O P

Złącze pomiarowe trójnikowe

Straight test coupling for metal pipe fitting

1

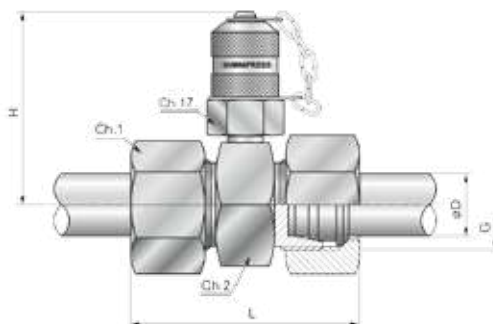

M16x2	Kod / Code	Seria / Series	D	G	H	L	Ch1	Ch2	PN [bar]
Trójnik pomiarowy / Ring fittings									
	S11306000C	L	6	M12x1,5	49	51	14	24	315
	S11308000C		8	M14x1,5	49	51	17	24	315
	S11310000C		10	M16x1,5	49	53	19	24	315
	S11312000C		12	M18x1,5	49	53	22	24	315
	S11315000C		15	M22x1,5	50,5	55	27	27	315
	S11318000C		18	M26x1,5	53	57	32	32	315
	S11322000C		22	M30x2	53	61	36	32	160
	S11328000C		28	M36x2	57,5	61	41	41	160
	S11335000C		35	M45x2	60	69	50	46	160
	S11342000C		42	M52x2	64,5	71	60	55	160
	S11406000C	S	6	M14x1,5	49	55	17	24	630
	S11408000C		8	M16x1,5	49	55	19	24	630
	S11410000C		10	M18x1,5	49	57	22	24	630
	S11412000C		12	M20x1,5	49	57	24	24	630
	S11414000C		14	M22x1,5	49	63	27	24	630
	S11416000C		16	M24x1,5	52	63	30	27	400
	S11420000C		20	M30x2	53	69	36	32	400
	S11425000C		25	M36x2	57,5	75	46	41	400
	S11430000C		30	M42x2	60	81	50	46	400
	S11438000C		38	M52x2	64,5	89	60	55	315

Opcje / Options



M16x1,5	Kod / Code	Seria / Series	D	G	H	L	Ch1	Ch2	PN [bar]
	S11310150C	L	10	M16x1,5	49	53	19	24	315
	S11312150C		12	M18x1,5	49	53	22	24	315
	S11315150C		15	M22x1,5	50,5	55	27	27	315
	S11408150C	S	8	M16x1,5	49	55	19	24	630

Opcje / Options



M12,65x1,65	Kod / Code	Seria / Series	D	G	H	L	Ch1	Ch2	PN [bar]
	S11310120C	L	10	M16x1,5	49	53	19	24	315
	S11312120C		12	M18x1,5	49	53	22	24	315

Opcje / Options



Złącze pomiarowe nastawne typ DKO

Test coupling with 24°O-Ring sealing cone DKO type

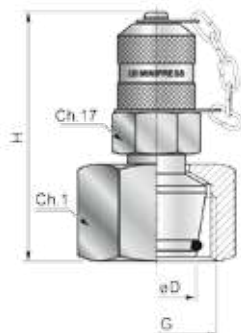

M16x2	Kod / Code	Seria / Series	D	G	H	Ch1	PN [bar]
	S11012X15C	L	6	M12x1,5	54	14	315
	S11014X15C		8	M14x1,5	54	17	315
	S11016X15C		10	M16x1,5	59	19	315
	S11018X15C		12	M18x1,5	59	22	315
	S11022X15C		15	M22x1,5	59	27	315
	S11026X15C		18	M26x1,5	59	32	315
	S11030X20C		22	M30x2	59	36	160
	S11035X20C		28	M36x2	60	41	160
	S11045X20C		35	M45x2	62	50	160
	S11052X20C		42	M52x2	65	60	160
	S11114X15C	S	6	M14x1,5	54	17	630
	S11116X15C		8	M16x1,5	54	19	630
	S11118X15C		10	M18x1,5	59	22	630
	S11120X15C		12	M20x1,5	59	24	630
	S11122X15C		14	M22x1,5	59	27	630
	S11124X15C		16	M24x1,5	60	30	400
	S11130X20C		20	M30x2	62	36	400
	S11136X20C		25	M36x2	65	46	400
	S11142X20C		30	M42x2	65	50	400
	S11152X20C		38	M52x2	65	60	315

Opcje / Options **O P**

M16x1,5	Kod / Code	Seria / Series	D	G	H	Ch1	PN [bar]
	S11022X15150C	L	15	M22x1,5	59	27	315
	S11030X20150C		22	M30x2	59	36	160
	S11116X15150C	S	8	M16x1,5	54	19	630

Opcje / Options **O P**

M12,65x1,65	Kod / Code	Seria / Series	D	G	H	Ch1	PN [bar]
	S11012X15120C	L	6	M12x1,5	54	14	315
	S11116X20120C		8	M16x1,5	54	19	630
	S11118X15120C	S	10	M18x1,5	59	22	630

Opcje / Options **O P**

Złącze pomiarowe wew/zew BSP

Check coupling male - female swivel 60°

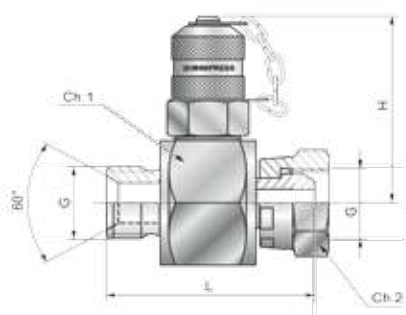

Kod / Code	G	H	L	Ch1	Ch2	PN [bar]
S11914G00C	ISO 228 G 1/4"	55	53	32	19	400
S11938G00C	ISO 228 G 3/8"	55	60	32	22	400
S11912G00C	ISO 228 G 1/2"	55	60	32	27	400
S11934G00C	ISO 228 G 3/4"	55	68	32	32	400
S11901G00C	ISO 228 G 1"	60	74	41	41	315

Opcje / Options **O P**

Złącze pomiarowe grodziowe - JIC 37°

Bulkhead test coupling - JIC 37°

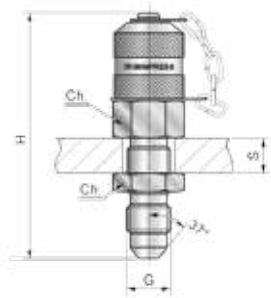

Kod / Code	G	H	Ch	S max	PN [bar]
S11707162C	7/16"-20 UNF	68	17	9	630
S11701220C	1/2"-20 UNF	68	17	9	400
S11709161C	9/16"-18 UNF	69	19	9	315

Opcje / Options **O** **P**

Złącze pomiarowe nastawne - JIC 37°

Female swivel test coupling - JIC 37°

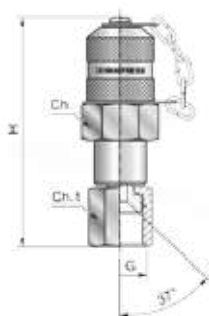

Kod / Code	G	H	Ch	Ch1	PN [bar]
S11507163C	7/16"-20 UNF	64	17	14	630
S11512203C	1/2"-20 UNF	65	17	17	400
S11509163C	9/16"-18 UNF	67	17	19	315
S11506163C	3/4"-16 UNF	70	17	22	315

Opcje / Options **O** **P**

Żeńskie przyłącze pomiarowe - JIC 37°

Female fixed test coupling - JIC 37°

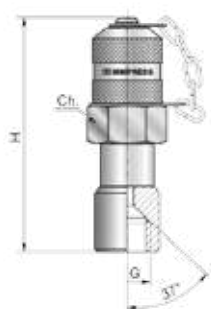

Kod / Code	G	H	Ch	PN [bar]
S115071FFC	7/16"-20 UNF	63	19	630
S115012FFC	1/2"-20 UNF	63	17	400
S115091FFC	9/16"-18 UNF	66	19	315
S115091FFAIC	3/4"-16 UNF	66	19	315

Opcje / Options **O** **P**

Złącze pomiarowe nastawne ORFS

ORFS female swivel test coupling

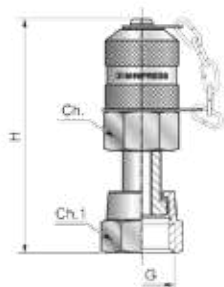

Kod / Code	G	H	Ch	Ch1	PN [bar]
S115916FSC	9/16"-18 UNF	53	17	19	400
S115116FSC	11/16"-16 UNF	54	17	22	400
S115131FSC	13/16"-16 UNF	58	19	24	400

Opcje / Options

 O P

Złącze pomiarowe nastawne BSP

Female swivel check - coupling

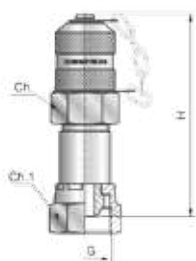

Kod / Code	G	H	Ch	Ch1	PN [bar]
S115914G0C	ISO 228 G 1/4"	62	19	19	630

Opcje / Options

 O P

Szybkozłącze pomiarowe 15QC000C

Test quick coupling 15QC000C



Szybkozłącze diagnostyczne, daje możliwość kontrolowania parametrów oleju w wysokociśnieniowych układach hydraulicznych. Gniazdo zakończone jest złączem minimesowym pod przewód pomiarowy M16x2. Zamienne z szybkozłączami ISO 15171-1 innych producentów.

Norma: ISO 15171-1**Zastosowanie:** diagnostyka układów hydraulicznych**Ciśnienie robocze:** 400 bar**Materiał:** stal ocynkowana**Uszczelnienie:** NBR (od -40°C do +120°C)

Diagnostic quick coupling gives the opportunity to control the parameters of high-pressure oil hydraulic systems. Socket part has a minimes thread M16x2 for micro hose. Interchangeable with other ISO 15171-1.

Norm: ISO 15171-1**Application:** diagnostic of hydraulic systems**Working pressure:** 400 bar**Material:** zinc steel**Seal:** NBR (from -40°C to +120°C)

Przyłącza pomiarowe wtykowe

Plug - in test couplings

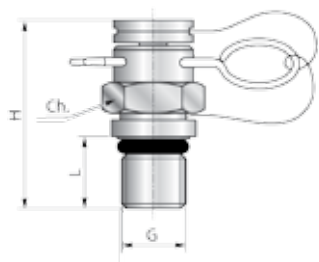

Kod / Code	G	H	L	Ch	PN [bar]	Uszczelka / Seal
Gwint: Przyłącze metryczne / Threaded: metric parallel (UNI 4535-64)						
51000000	M8x1	25	8,5	12	250	O-Ring Typ A
51100000	M10x1	25	8,5	14	400	O-Ring Typ A

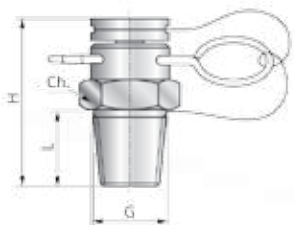

Kod / Code	G	H	L	Ch	PN [bar]	Uszczelka / Seal
Gwint: stożek BSP / Threaded: B.S.P. taper (UNI ISO 7/1)						
51800000	ISO 7/1 R 1/8"	25	12	12	400	Typ D
Gwint: stożek BSP / Threaded: B.S.P. taper NPTF (ANSI/ASME B.1.20.1 - 1983)						
51900000	1/8" NPTF	25	12	12	400	Typ D

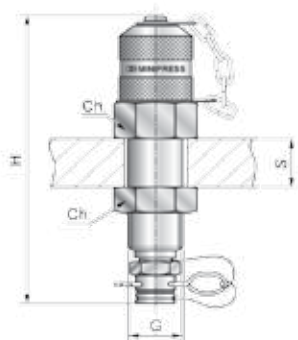

Kod / Code	G	H	Ch	S max	PN [bar]
Złącze pomiarowe grodziowe / Bulkhead test coupling					
23PPIB0C	M16x2	90	19	25	400

1

Przyłącza pomiarowe wtykowe nastawne typ DKO

Plug - in test coupling with 24° O-Ring sealing cone DKO type

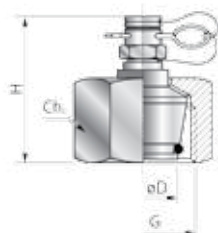

Kod / Code	Seria / Series	D	G	H	Ch	PN [bar]
1016X15B	L	10	M16x1,5	39	19	315
1018X15B		12	M18x1,5	39	22	315
1022X15B		15	M22x1,5	39	27	315
1026X15B		18	M26x1,5	39	32	315
1030X20B		22	M30x2	39	36	160
1035X20B		28	M36x2	40	41	160
1045X20B		35	M45x2	42	50	160
1052X20B		42	M52x2	45	60	160
1118X15B		S	10	M18x1,5	39	22
1120X15B	12		M20x1,5	39	24	630
1122X15B	14		M22x1,5	39	27	630
1124X15B	16		M24x1,5	40	30	400
1130X20B	20		M30x2	42	36	400
1136X20B	25		M36x2	44	46	400
1142X20B	30		M42x2	44	50	400
1152X20B	38		M52x2	44	60	315

Przyłącze pomiarowe wtykowe trójnikowe metryczne

Plug - in straight test coupling for metal pipe fitting

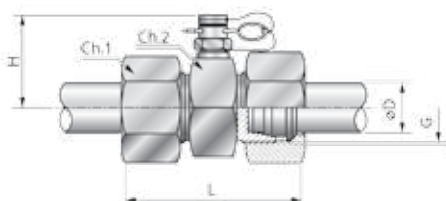

Kod / Code	Seria / Series	D	G	H	L	Ch1	Ch2	PN [bar]	
Trójnik pomiarowy / Ring fittings									
1306000B	L	6	M12x1,5	29	51	14	24	315	
1308000B		8	M14x1,5	29	51	17	24	315	
1310000B		10	M16x1,5	29	53	19	24	315	
1312000B		12	M18x1,5	29	53	22	24	315	
1315000B		15	M22x1,5	30,5	55	27	27	315	
1318000B		18	M26x1,5	33	57	32	32	315	
1322000B		22	M30x2	33	61	36	32	160	
1328000B		28	M36x2	37,5	61	41	41	160	
1335000B		35	M45x2	40	69	50	46	160	
1342000B		42	M52x2	44,5	71	60	55	160	
1406000B		S	6	M14x1,5	29	55	17	24	630
1408000B			8	M16x1,5	29	55	19	24	630
1410000B	10		M18x1,5	29	57	22	24	630	
1412000B	12		M20x1,5	29	57	24	24	630	
1414000B	14		M22x1,5	29	63	27	24	630	
1416000B	16		M24x1,5	32	63	30	27	400	
1420000B	20		M30x2	33	69	36	32	400	
1425000B	25		M36x2	37,5	75	46	41	400	
1430000B	30		M42x2	40	81	50	46	400	
1438000B	38		M52x2	44,5	89	60	55	315	

Złącza pomiarowe do manometrów

Pressure gauge adapters

1

Sposób zamówienia

How to order

Konfiguracja / Configuration

Kod złączki zakończony „0” / Adapters code ends with “0”

xxxxxxx0

Opcje / Options

Złącze pomiarowe z tłumionym przepływem na zamówienie /
Pressure damper on request

S

Zamień „0” na „S” / Replace “0” with “S”

xxxxxxxS

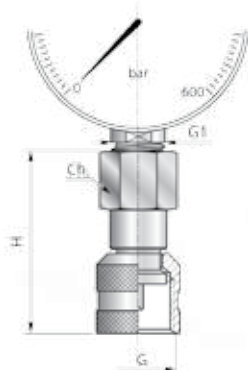

Kod / Code	G	G1	H	Ch	PN [bar]
Bezpośrednie podłączenie manometru / Direct gauge adapter					
20140000	M16x2	ISO 228 G 1/4"	50	19	630
20120000	M16x2	ISO 228 G 1/2"	55	27	630
20141500	M16x1,5	ISO 228 G 1/4"	50	19	630
20121500	M16x1,5	ISO 228 G 1/2"	55	27	630
20141200	S12,65x1,65	ISO 228 G 1/4"	50	19	630
2014NPT0	M16x2	1/4" -18 NPTF	50	19	630

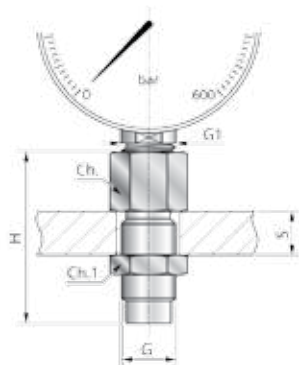

Kod / Code	G	G1	H	Ch	Ch1	S Max	PN [bar]
Grodziowe podłączenie manometru / Bulkhead pressure gauge connection							
18140000	M16x2	ISO 228 G 1/4"	50	19	19	11	630
18120000	M16x2	ISO 228 G 1/2"	57	27	19	13	630
18141500	M16x1,5	ISO 228 G 1/4"	50	19	19	11	630
1814NPT0	M16x2	1/4"-18 NPTF	50	19	19	11	630

Uwaga: Bez zaworu zwrotnego

Note: Without check valve

Opcje / Options

S

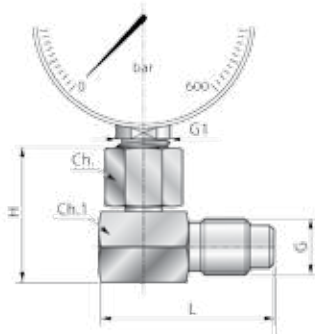

Kod / Code	G	G1	H	L	Ch	Ch1	PN [bar]
Kolankowe podłączenie manometru / Swivel pressure gauge connection 90° angle							
21140000	M16x2	ISO 228 G 1/4"	36	42	19	19	630
21120000	M16x2	ISO 228 G 1/2"	43	42	27	19	630
21141500	M16x1,5	ISO 228 G 1/4"	36	42	19	19	630
21121500	M16x1,5	ISO 228 G 1/2"	43	42	27	19	630

Uwaga: Bez zaworu zwrotnego

Note: Without check valve

Opcje / Options

S

Złączki

Adapters

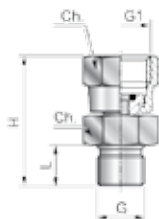

Kod / Code	G1	G	H	L	Ch	PN [bar]
Nastawne przyłącze manometru / Swivel pressure gauge connection						
1814M000	ISO 228 G 1/4"	ISO 228 G 1/4"	34	11	17	400
1812M000	ISO 228 G 1/2"	ISO 228 G 1/2"	46	15	27	400
1814M120	ISO 228 G 1/2"	ISO 228 G 1/4"	50	13	27	400
1814M700	ISO 228 G 1/8"	ISO 228 G 1/4"	36,5	14	19	400
1814MBSPT	ISO 228 G 1/4"	ISO 7/1 R 1/4"	34	12	17	400
1812MBSPT	ISO 228 G 1/2"	ISO 7/1 R 1/2"	46	16	27	400

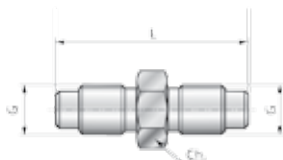

Kod / Code	G	L	Ch	PN [bar]
Złączka pomiarowa / Straight adapter for connection of hoses. Free flow.				
40GD0000	M16x2	43	17	630
40GD1500	M16x1,5	43	17	630

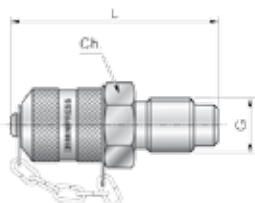

Kod / Code	G	L	Ch	PN [bar]
Złącze pomiarowe z zaworem zwrotnym / Straight adapter with no-return valve				
41GV000C	M16x2	53	17	630

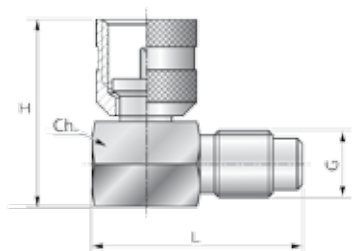

Kod / Code	G	H	L	Ch	PN [bar]
Złączka kolankowa nastawna / 90° Swivel adapter					
24GG0000	M16x2	42	41	19	630
24GG1500	M16x1,5	42	41	19	630

Sposób zamówienia

How to order

Przykładowe oznaczenie przewodu / Order code								
RD2	-	31TTN0	0	-	361400	0	-	1500
1		2	3	4	5	6		

- 1** Typ węża / Hose type
- 2** Oznaczenie końcówki / Fitting type
- 3** Kąt wygięcia końcówki / Elbow fitting angle
- 4** Oznaczenie końcówki / Fitting type
- 5** Kąt wygięcia końcówki / Elbow fitting angle
- 6** Długość przewodu / Hose length

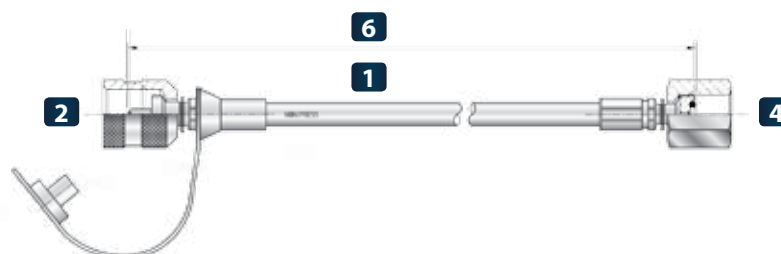
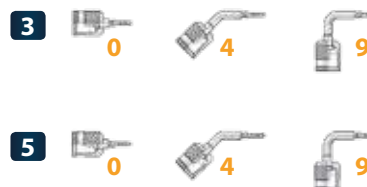

Referencje

Reference regulations

Oznaczenie typu węża / Hose code				
RD2 - RD3 - RD4				
Przeznaczenie: olej mineralny, typ ASTM 3, olej napędowy, olej do systemów hamulcowych (typ DOT 4) / For mineral and hydraulic oil, type ASTM 3, fuel. Brake systems oil (type DOT 4).				
		RD2	RD3	RD4
Średnicazew./Outside diameter	[mm]	5	6	8
Średnicawew./Inside diameter	[mm]	2	3	4
Max. ciśnienie pracy / Max working pressure	[bar]	630	630	500
Min. ciśnienie rozrywające / Min. Bursting pressure	[bar]	1890	1890	1500
Min. promień gięcia / Min. Bending radius	[mm]	20	25	35
Temperatura pracy / Working temperature	°C	-40...+100	-40...+100	-40...+100
Materiał warstwy wewnętrznej / Core material	Poliester termoplastyczny / Thermoplastic polyester			
Materiał oplotu / Braid material	Włókna aramidowe „kevlar” / Aramidic fibre “kevlar”			
Materiał warstwy zewnętrznej / Cover material	Poliuretan odporny na ścieranie / Antiabrasion polyurethane			

Końcówka przewodu pomiarowego do złącza pomiarowego

Test coupling threaded female fitting

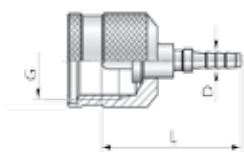

Kod / Code	Wąż / Hose	G	L	D
31TTN000	RD2	M16x2	32,5	2,0
31TNAI00		M16x2*	32,5	2,0
31TTS000		M16x1,5	32,5	2,0
31S12000		M12,65x1,65	32,5	2,0
31TTN003	RD3	M16x2	37,2	3,0
31TTS003		M16x1,5	37,2	3,0
31S12003		M12,65x1,65	37,2	3,0
31TTN004	RD4	M16x2	36,5	4,0
31TTS004		M16x1,5	36,5	4,0
31S12004		M12,65x1,65	36,5	4,0

*Stal nierdzewna / Stainless steel

45°

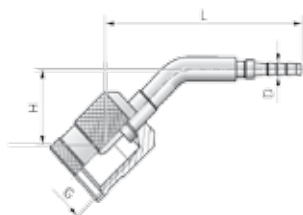

Kod / Code	Wąż / Hose	G	L	H	D
31TTN040	RD2	M16x2	48	18	2,0
31TTS040		M16x1,5	48	18	2,0
31S12040		M12,65x1,65	48	18	2,0
31TTN043	RD3	M16x2	48	18,5	3,0
31TTS043		M16x1,5	48	18,5	3,0
31S12043		M12,65x1,65	48	18,5	2,0
31TTN044	RD4	M16x2	53	18,5	4,0
31TTS044		M16x1,5	53	18,5	4,0
31S12044		M12,65x1,65	53	18,5	4,0

90°

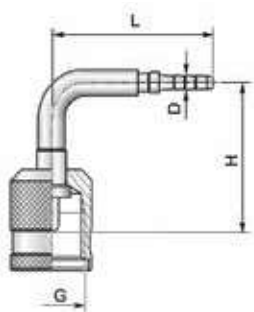

Kod / Code	Wąż / Hose	G	L	H	D
31TTN090	RD2	M16x2	34,5	31	2,0
31TTS090		M16x1,5	34,5	31	2,0
31S12090		M12,65x1,65	34,5	31	2,0
31TTN093	RD3	M16x2	34,5	31	3,0
31TTS093		M16x1,5	34,5	31	3,0
31S12093		M12,65x1,65	34,5	31	3,0
31TTN094	RD4	M16x2	34,5	31	4,0
31TTS094		M16x1,5	34,5	31	4,0
31S12094		M12,65x1,65	34,5	31	4,0

Końcówka przewodu pomiarowego do złącza pomiarowego, nakrętka z sześciokątem

Test coupling threaded female fitting with hexagonal nut

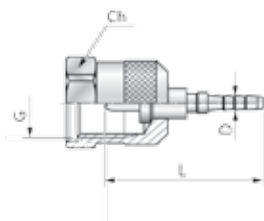

Kod / Code	Wąż / Hose	G	L	Ch	D
31TTN600	RD2	M16x2	32,5	19	2,0
31TTN6A1		M16x2*	32,5	19	2,0
31TTS600		M16x1,5	32,5	19	2,0
31TTN603	RD3	M16x2	37,2	19	3,0
31TTS603		M16x1,5	37,2	19	3,0
31TTN604	RD4	M16x2	36,5	19	4,0
31TTS604		M16x1,5	36,5	19	4,0

*Stal nierdzewna/ Stainless steel

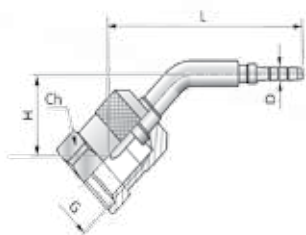

45°						
Kod / Code	Wąż / Hose	G	L	H	Ch	D
31TTN640	RD2	M16x2	48	18	19	2,0
31TTS640		M16x1,5	48	18	19	2,0
31TTN643	RD3	M16x2	48	18,5	19	3,0
31TTS643		M16x1,5	48	18,5	19	3,0
31TTN644	RD4	M16x2	53	18,5	19	4,0
31TTS644		M16x1,5	53	18,5	19	4,0

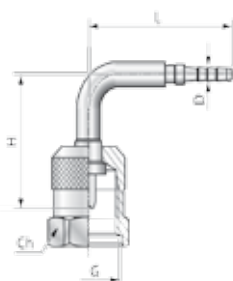

90°						
Kod / Code	Wąż / Hose	G	L	H	Ch	D
31TTN690	RD2	M16x2	34,5	31	19	2,0
31TTS690		M16x1,5	34,5	31	19	2,0
31TTN693	RD3	M16x2	34,5	31	19	3,0
31TTS693		M16x1,5	34,5	31	19	3,0
31TTN694	RD4	M16x2	34,5	31	19	4,0
31TTS694		M16x1,5	34,5	31	19	4,0

Końcówka przewodu pomiarowego pod przyłącze manometru z O-Ringiem

Gauges threaded fitting

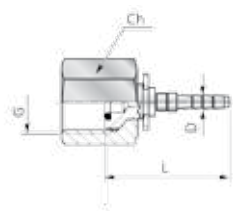

Kod / Code	Wąż / Hose	G	L	Ch	D
36140000	RD2	G 1/4"	26	19	2
3614AI00		G 1/4"*	26	19	2
36120000		G 1/2"	33,5	27	2
36M2OR00		M20x1,5	33,5	24	2
3614OR03	RD3	G 1/4"	30	19	3
3612OR03		G 1/2"	37,5	27	3
36M2OR03		M20x1,5	37,5	24	3
3614OR04	RD4	G 1/4"	36,5	19	4
3612OR04		G 1/2"	37,5	27	4
36M2OR04		M20x1,5	37,5	24	4

*Stal nierdzewna / Stainless steel

45°

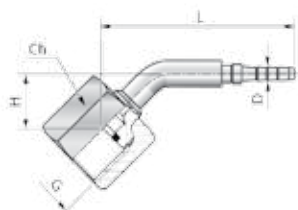

Kod / Code	Wąż / Hose	G	H	L	Ch	D
36140040	RD2	G 1/4"	14	47	19	2
36120040		G 1/2"	21	54,5	27	2
36M2OR40		M20x1,5	21	54,5	24	2
3614OR43	RD3	G 1/4"	14	47	19	3
3612OR43		G 1/2"	21	54,5	27	3
36M2OR43		M20x1,5	21	54,5	24	3
3614OR44	RD4	G 1/4"	14	52	19	4
3612OR44		G 1/2"	21	59,5	27	4
36M2OR44		M20x1,5	21	59,5	24	4

90°

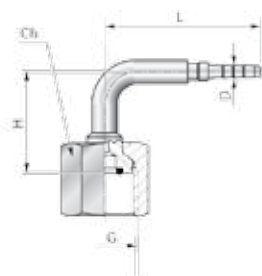

Kod / Code	Wąż / Hose	G	H	L	Ch	D
36140090	RD2	G 1/4"	25	38	19	2
36120090		G 1/2"	37,5	41,5	27	2
36M2OR90		M20x1,5	37,5	41,5	24	2
3614OR93	RD3	G 1/4"	25	38	19	3
3612OR93		G 1/2"	37,5	41,5	27	3
36M2OR93		M20x1,5	37,5	41,5	24	3
3614OR94	RD4	G 1/4"	25	43	19	4
3612OR94		G 1/2"	37,5	46,5	27	4
36M2OR94		M20x1,5	37,5	46,5	24	4

Końcówka przewodu pomiarowego pod przyłącze manometru

Gauges threaded fitting

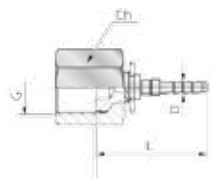

Kod / Code	Wąż / Hose	G	L	Ch	D
3614CR00	RD2	G 1/4"	26	19	2
3612CR00		G 1/2"	33,5	27	2
36M2CR00		M20x1,5	33,5	24	2
3614CR03	RD3	G 1/4"	30	19	3
3612CR03		G 1/2"	37,5	27	3
36M2CR03		M20x1,5	37,5	24	3
3614CR04	RD4	G 1/4"	36,5	19	4
3612CR04		G 1/2"	37,5	27	4
36M2CR04		M20x1,5	36,5	24	4

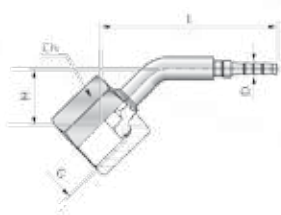

45°						
Kod / Code	Wąż / Hose	G	H	L	Ch	D
3614CR40	RD2	G 1/4"	14	47	19	2
3612CR40		G 1/2"	21	54,5	27	2
36M2CR40		M20x1,5	21	54,5	24	2
3614CR43	RD3	G 1/4"	14	47	19	3
3612CR43		G 1/2"	21	54,5	27	3
36M2CR43		M20x1,5	21	54,5	24	3
3614CR44	RD4	G 1/4"	14	52	19	4
3612CR44		G 1/2"	21	59,5	27	4
36M2CR44		M20x1,5	21	59,5	24	4

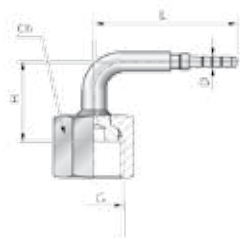

90°						
Kod / Code	Wąż / Hose	G	H	L	Ch	D
3614CR90	RD2	G 1/4"	25	38	19	2
3612CR90		G 1/2"	37,5	41,5	27	2
36M2CR90		M20x1,5	37,5	41,5	24	2
3614CR93	RD3	G 1/4"	25	38	19	3
3612CR93		G 1/2"	37,5	41,5	27	3
36M2CR93		M20x1,5	37,5	41,5	24	3
3614CR94	RD4	G 1/4"	25	43	19	4
3612CR94		G 1/2"	37,5	46,5	27	4
36M2CR94		M20x1,5	37,5	46,5	24	4

Końcówka przewodu pomiarowego z gwintem wewnętrznym BSP, płaska

Gauges threaded fitting

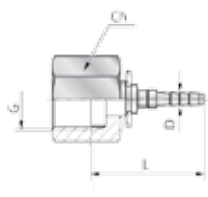

Kod / Code	Wąż / Hose	G	L	Ch	D
4918DF00	RD2	G 1/8"	22,6	14	2
4914DF00		G 1/4"	23,5	17	2
4918DF03	RD3	G 1/8"	26,6	14	3
4914DF03		G 1/4"	27,5	17	3
4918DF04	RD4	G 1/8"	26,6	14	4
4914DF04		G 1/4"	27,5	17	4

2

Końcówka przewodu pomiarowego z gwintem wewnętrznym NPTF

Gauges threaded fitting

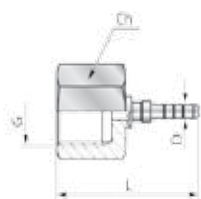

Kod / Code	Wąż / Hose	G	L	19	D
37140000	RD2	1/4"-18NPTF	30	19	2
37140003	RD3	1/4"-18NPTF	34	19	3
37140004	RD4	1/4"-18NPTF	34	19	4

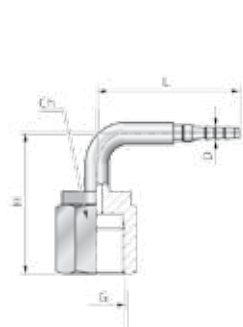

90°						
Kod / Code	Wąż / Hose	G	H	L	Ch	D
37140090	RD2	1/4"-18NPTF	28,5	36	19	2
37140093	RD3	1/4"-18NPTF	28,5	36	19	3
37140094	RD4	1/4"-18NPTF	28,5	36	19	4

Końcówka przewodu pomiarowego DKR, stożek 60°

Swivel female fitting 60° cone connection type DKR

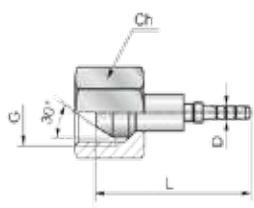

Kod / Code	Wąż / Hose	G	L	Ch	D
38180000	RD2	G 1/8"	24	14	2
38140000		G 1/4"	26	17	2
3814AI00		G 1/4"*	26	17	2
38380000		G 3/8"	29	22	2
38121500		M12x1,5	24	14	2
38180003	RD3	G 1/8"	28	14	3
38140003		G 1/4"	30	17	3
38180004	RD4	G 1/8"	31	14	4
38140004		G 1/4"	32,5	17	4

*Stal nierdzewna / Stainless steel

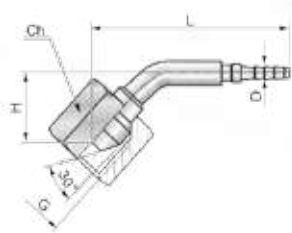

45°						
Kod / Code	Wąż / Hose	G	H	L	Ch	D
38180040	RD2	G 1/8"	15	44,5	14	2
38140040		G 1/4"	16	47,5	17	2
38180043	RD3	G 1/8"	15	49,5	14	3
38140043		G 1/4"	16	47,5	17	3
38180044	RD4	G 1/8"	15	49,5	14	4
38140044		G 1/4"	16	52,5	17	4

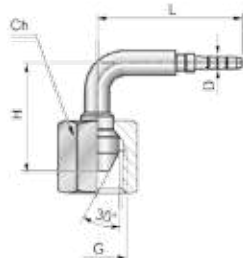

90°						
Kod / Code	Wąż / Hose	G	H	L	Ch	D
38180090	RD2	G 1/8"	26	34	14	2
38140090		G 1/4"	27,5	36,5	17	2
38180093	RD3	G 1/8"	26	39	14	3
38140093		G 1/4"	27,5	36,5	17	3
38180094	RD4	G 1/8"	26	39	14	4
38140094		G 1/4"	27,5	41,5	17	4

Końcówka przewodu pomiarowego DKL, współpracująca z gniazdem 24°

Swivel female fitting 24° cone connection type DKL

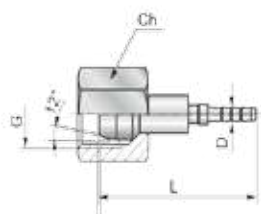

Kod / Code	Wąż / Hose	Ø	G	L	Ch	D
45R00000	RD2	6	M12x1,5	36	14	2
45R20000		8	M14x1,5	35	17	2
45R50000		10	M16x1,5	36,5	19	2
45R00003	RD3	6	M12x1,5	35	14	3
45R20003		8	M14x1,5	35	17	3
45R50003		10	M16x1,5	36,5	19	3
45R00004	RD4	6	M12x1,5	36	14	4
45R20004		8	M14x1,5	36	17	4
45R50004		10	M16x1,5	41,5	19	4

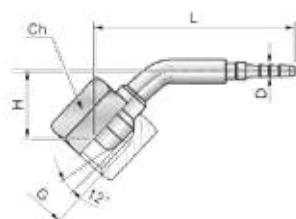

45°							
Kod / Code	Wąż / Hose	Ø	G	H	L	Ch	D
45R00040	RD2	6	M12x1,5	19,5	53,5	14	2
45R20040		8	M14x1,5	19	51	17	2
45R50040		10	M16x1,5	22,5	56	19	2
45R00043	RD3	6	M12x1,5	19,5	53,5	14	3
45R20043		8	M14x1,5	19	51	17	3
45R50043		10	M16x1,5	22,5	56	19	3
45R00044	RD4	6	M12x1,5	19,5	58,5	14	4
45R20044		8	M14x1,5	19	56	17	4
45R50044		10	M16x1,5	22,5	61	19	4

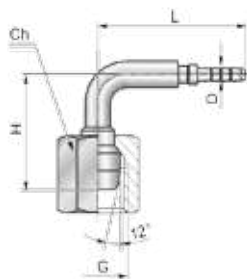

90°							
Kod / Code	Wąż / Hose	Ø	G	H	L	Ch	D
45R00090	RD2	6	M12x1,5	31,5	47,5	14	2
45R20090		8	M14x1,5	36	40	17	2
45R50090		10	M16x1,5	40	41,5	19	2
45R00093	RD3	6	M12x1,5	28,5	39	14	3
45R20093		8	M14x1,5	36	40,5	17	3
45R50093		10	M16x1,5	40	41,5	19	3
45R00094	RD4	6	M12x1,5	36	47	14	4
45R20094		8	M14x1,5	36	45,5	17	4
45R50094		10	M16x1,5	40	46,5	19	4

Końcówka przewodu pomiarowego DKOL, stożek 24° z O-Ringiem

Swivel female fitting 24° cone connection type DKOL

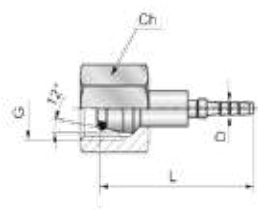

Kod / Code	Wąż / Hose	Ø	G	L	Ch	D
35R00000	RD2	6	M12x1,5	31,6	14	2
35R20000		8	M14x1,5	31,6	17	2
35R50000		10	M16x1,5	31,6	19	2
35R60000		12	M18x1,5	34	22	2
35R00003	RD3	6	M12x1,5	35	14	3
35R20003		8	M14x1,5	35	17	3
35R50003		10	M16x1,5	36,5	19	3
35R00004	RD4	6	M12x1,5	35,5	14	4
35R20004		8	M14x1,5	36	17	4
35R50004		10	M16x1,5	36,5	19	4
35R60004		12	M18x1,5	38	22	4

45°

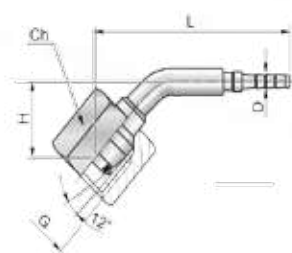

Kod / Code	Wąż / Hose	Ø	G	H	L	Ch	D
35R00040	RD2	6	M12x1,5	19,5	53,5	14	2
35R20040		8	M14x1,5	19	51	17	2
35R50040		10	M16x1,5	19	56	19	2
35R00043	RD3	6	M12x1,5	19,5	53,5	14	3
35R20043		8	M14x1,5	19	51	17	3
35R50043		10	M16x1,5	22,5	61	19	3
35R00044	RD4	6	M12x1,5	19,5	58,5	14	4
35R20044		8	M14x1,5	19	56	17	4
35R50044		10	M16x1,5	22,5	61	19	4
35R60044		12	M18x1,5	22,5	61	22	4

90°

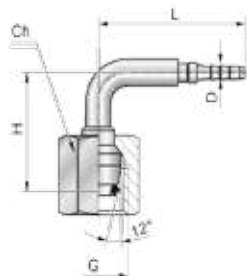

Kod / Code	Wąż / Hose	Ø	G	H	L	Ch	D
35R00090	RD2	6	M12x1,5	36	42	14	2
35R20090		8	M14x1,5	36	40,5	17	2
35R50090		10	M16x1,5	40	41,5	19	2
35R00093	RD3	6	M12x1,5	36	42	14	3
35R20093		8	M14x1,5	36	40,5	17	3
35R50093		10	M16x1,5	40	46,5	19	3
35R00094	RD4	6	M12x1,5	36	47	14	4
35R20094		8	M14x1,5	36	45,5	17	4
35R50094		10	M16x1,5	40	46,5	19	4
35R60094		12	M18x1,5	40	46,5	22	4

Końcówka przewodu pomiarowego DKOLL, stożek 24° z O-Ringiem

Swivel female fitting 24° cone connection type DKOLL

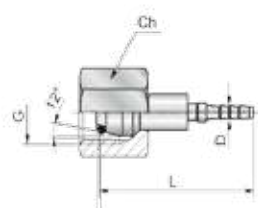

Kod / Code	Wąż / Hose	Ø	G	L	Ch	D
46R00000	RD2	4	M8x1	29,5	10	2
46R10000		6	M10x1	30	12	2
46R00003	RD3	4	M8x1	33	10	3
46R10003		6	M10x1	34	12	3
46R00004	RD4	4	M8x1	33	10	4
46R10004		6	M10x1	34	12	4

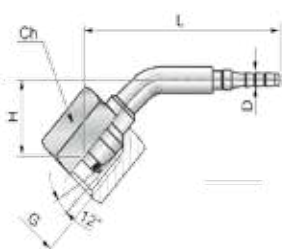

45°

Kod / Code	Wąż / Hose	Ø	G	H	L	Ch	D
46R10040	RD2	6	M10x1	15	53	12	2
46R10043	RD3	6	M10x1	15	57	12	3
46R10044	RD4	6	M10x1	15	57	12	4

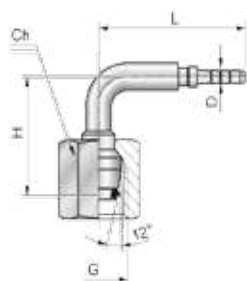

90°

Kod / Code	Wąż / Hose	Ø	G	H	L	Ch	D
46R10090	RD2	6	M10x1	28,5	39	12	2
46R10093	RD3	6	M10x1	28,5	43	12	3
46R10094	RD4	6	M10x1	24,5	47,3	12	4

Końcówka przewodu pomiarowego DKOS, stożek 24° z O-Ringiem

Swivel female fitting 24° cone connection type DKOS

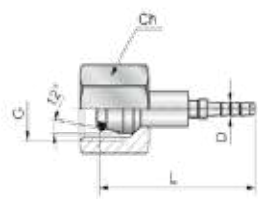

Kod / Code	Wąż / Hose	Ø	G	L	Ch	D
35R10000	RD2	6	M14x1,5	31,6	17	2
35R30000		8	M16x1,5	31,6	19	2
35R40000		10	M18x1,5	31,5	22	2
35R70000		12	M20x1,5	34	24	2
35R10003	RD3	6	M14x1,5	35	17	3
35R30003		8	M16x1,5	35	19	3
35R40003		10	M18x1,5	36,5	22	3
35R10004	RD4	6	M14x1,5	35,5	17	4
35R30004		8	M16x1,5	36	19	4
35R40004		10	M18x1,5	36,5	22	4

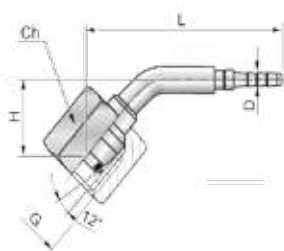

45°							
Kod / Code	Wąż / Hose	Ø	G	H	L	Ch	D
35R10040	RD2	6	M14x1,5	19,5	53,5	17	2
35R30040		8	M16x1,5	19	51	19	2
35R40040		10	M18x1,5	19	56	22	2
35R10043	RD3	6	M14x1,5	19,5	53,5	17	3
35R30043		8	M16x1,5	19	51	19	3
35R40043		10	M18x1,5	22,5	61	22	3
35R10044	RD4	6	M14x1,5	19,5	58,5	17	4
35R30044		8	M16x1,5	19	56	19	4
35R40044		10	M18x1,5	22,5	61	22	4
35R70044		12	M20x1,5	22,5	61	24	4

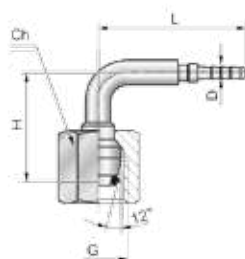

90°							
Kod / Code	Wąż / Hose	Ø	G	H	L	Ch	D
35R10090	RD2	6	M14x1,5	36	42	17	2
35R30090		8	M16x1,5	36	40,5	19	2
35R40090		10	M18x1,5	40	41,5	22	2
35R10093	RD3	6	M14x1,5	36	42	17	3
35R30093		8	M16x1,5	36	40,5	19	3
35R40093		10	M18x1,5	40	46,5	22	3
35R10094	RD4	6	M14x1,5	36	47	17	4
35R30094		8	M16x1,5	36	45,5	19	4
35R40094		10	M18x1,5	40	46,5	22	4
35R70094		12	M20x1,5	40	46,5	24	4

Końcówka przewodu pomiarowego DKJ, JIC stożek wewnętrzny 74°

Swivel female fitting JIC 74° connection type DKJ

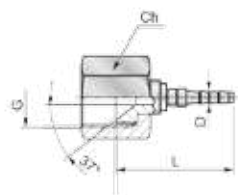

Kod / Code	Wąż / Hose	G	L	Ch	D
39160000	RD2	7/16"-20 UNF	25	14	2
3916AI00		7/16"-20 UNF*	25	14	2
39120000		1/2"-20 UNF	26	17	2
3938J000		3/8"-24 UNF	24,5	12	2
3938JA10		3/8"-24 UNF*	24,5	12	2
3991J000		9/16"-18 UNF	28,5	17	2
39160003	RD3	7/16"-20 UNF	29	14	3
39120003		1/2"-20 UNF	30	17	3
3938J003		3/8"-24 UNF	27	12	3
39160004	RD4	7/16"-20 UNF	28	14	4
3916AI04		7/16"-20 UNF*	28	14	4
39120004		1/2"-20 UNF	30	17	4
3938J004		3/8"-24 UNF	28,5	12	4

*Stal nierdzewna / Stainless steel

45°

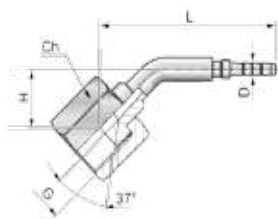

Kod / Code	Wąż / Hose	G	H	L	Ch	D
39160040	RD2	7/16"-20 UNF	13	46,5	14	2
39120040		1/2"-20 UNF	13	46,5	17	2
3938J040		3/8"-24 UNF	14	46	12	2
3991J040		9/16"-18 UNF	15,5	54,5	17	2
39160043	RD3	7/16"-20 UNF	13	46,5	14	3
39120043		1/2"-20 UNF	13	51,5	17	3
3938J043		3/8"-24 UNF	14	46	12	3
39160044	RD4	7/16"-20 UNF	13	51,5	14	4
39120044		1/2"-20 UNF	13	51,5	17	4
3938J044		3/8"-24 UNF	14	46	12	4

90°

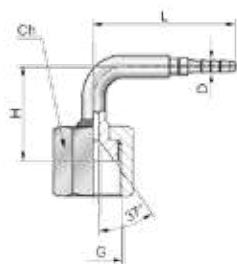

Kod / Code	Wąż / Hose	G	H	L	Ch	D
39160090	RD2	7/16"-20 UNF	23	38,5	14	2
39120090		1/2"-20 UNF	23	38,5	17	2
3938J090		3/8"-24 UNF	24	40	12	2
39160093	RD3	7/16"-20 UNF	23	46,5	14	3
39120093		1/2"-20 UNF	23	43,5	17	3
3938J093		3/8"-24 UNF	24	40	12	3
39160094	RD4	7/16"-20 UNF	23	43,5	14	4
39120094		1/2"-20 UNF	23	43,5	17	4
3938J094		3/8"-24 UNF	24	40	12	4

Końcówka przewodu pomiarowego rurkowa BEL/S

Standpipe fitting

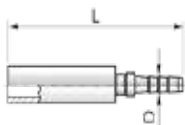

Kod / Code	Wąż / Hose	Ø	L	D
34R70000	RD2	4	36	2
34R00000		6	36	2
34R0A100		6*	36	2
34R30000		8	36	2
34R70003	RD3	4	36	3
34R00003		6	36	3
34R30003		8	37,5	3
34R70004	RD4	4	41	4
34R00004		6	41	4
34R30004		8	41	4

* Stal nierdzewna / Stainless steel

45°

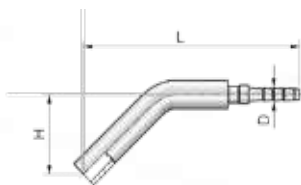

Kod / Code	Wąż / Hose	Ø	H	L	D
34R70040	RD2	4	14,5	43	2
34R00040		6	16,5	44	2
34R30040		8	20	52	2
34R70043	RD3	4	14,5	43	3
34R00043		6	16,5	44	3
34R30043		8	20	52	3
34R70044	RD4	4	14,5	48	4
34R00044		6	16,5	49	4
34R30044		8	20	57	4

90°

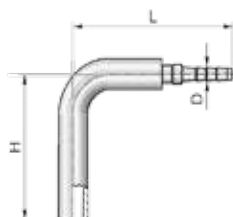

Kod / Code	Wąż / Hose	Ø	H	L	D
34R70090	RD2	4	25,5	33	2
34R00090		6	28	32	2
34R30090		8	37	41	2
34R70093	RD3	4	25,5	33	3
34R00093		6	28	32	3
34R30093		8	37	41	3
34R70094	RD4	4	25,5	38	4
34R00094		6	28	37	4
34R30094		8	37	46	4

Końcówka przewodu pomiarowego oczkowa

Banjo fitting

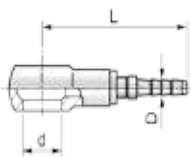

Kod / Code	Wąż / Hose	d	Śruba oczkowa / Banjo Screw	L	D
42R10000	RD2	8	M8x1	29,5	2
42R00000		10	M10x1-G 1/8"	31,5	2
42R10003	RD3	8	M8x1	36,5	3
42R00003		10	M10x1-G 1/8"	31,5	3
42R10004	RD4	8	M8x1	34,5	4
42R00004		10	M10x1-G 1/8"	36,5	4
42R20004		14	M14x1,5-G 1/4"	40,5	4

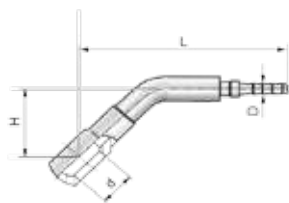

45°					
Kod / Code	Wąż / Hose	d	H	L	D
42R10040	RD2	8	22,5	45	2
42R00040		10	17	51	2
42R10043	RD3	8	15	51,5	3
42R00043		10	17	56	3
42R10044	RD4	8	15	51,5	4
42R00044		10	17	56	4

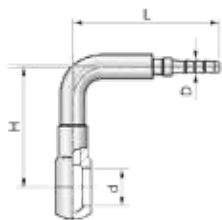

90°					
Kod / Code	Wąż / Hose	d	H	L	D
42R10090	RD2	8	26	36	2
42R00090		10	36	34	2
42R10093	RD3	8	26	41	3
42R00093		10	36	39	3
42R10094	RD4	8	26	41	4
42R00094		10	36	40	4

Śruba do końcówki oczkowej

Banjo screw

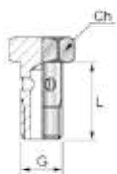

Kod / Code	G	L	Ch
1650-00-08	M8x1	17	12
1650-00-10	M10x1	19	14
1600-00-02	G 1/8"	19	14

Końcówka przewodu pomiarowego CEL, gniazdo 24°

Male fitting

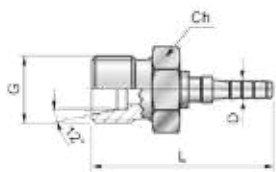

Kod / Code	Wąż / Hose	G	L	Ch	D
44MFLR00	RD2	M12x1,5	30	14	2
44MFLR10		M14x1,5	30	17	2
44MFLR30		M16x1,5	31	19	2
44MFLR03	RD3	M12x1,5	34	14	3
44MFLR13		M14x1,5	34	17	3
44MFLR33		M16x1,5	35	19	3
44MFLR04	RD4	M12x1,5	35	14	4
44MFLR14		M14x1,5	35	17	4
44MFLR34		M16x1,5	36	19	4

Końcówka przewodu pomiarowego AGR, stożek wewnętrzny 60° typ A

Male fitting

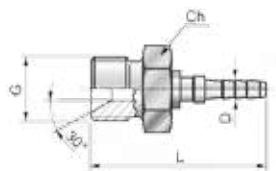

Kod / Code	Wąż / Hose	G	L	Ch	D
44MFG180	RD2	G 1/8"	29	14	2
44MFG140		G 1/4"	34	19	2
44MFG183	RD3	G 1/8"	34,5	14	3
44MFG143		G 1/4"	36,5	19	3
44MFG184	RD4	G 1/8"	37	14	4
44MFG144		G 1/4"	36,5	19	4
44MFG384		G 3/8"	42,5	22	4

Końcówka przewodu pomiarowego AGR, stożek wewnętrzny 60° typ B

Male fitting

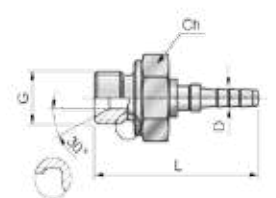

Kod / Code	Wąż / Hose	G	L	Ch	D
44MFM180	RD2	G 1/8"	31,5	14	2
44MFM140		G 1/4"	35,5	19	2
44MFM183	RD3	G 1/8"	30,5	14	3
44MFM143		G 1/4"	39	19	3
44MFM184	RD4	G 1/8"	33,5	14	4
44MFM144		G 1/4"	40,5	19	4

Końcówka przewodu pomiarowego CES, gniazdo 24°

Male fitting

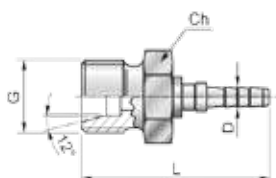

Kod / Code	Wąż / Hose	G	L	Ch	D
44MFSR00	RD2	M14x1,5	32	17	2
44MFSR10		M16x1,5	32	19	2
44MFSR20		M18x1,5	33,5	22	2
44MFSR03	RD3	M14x1,5	36	17	3
44MFSR13		M16x1,5	36	19	3
44MFSR23		M18x1,5	36,5	22	3
44MFSR04	RD4	M14x1,5	37	17	4
44MFSR14		M16x1,5	37	19	4
44MFSR24		M18x1,5	38,5	22	4
44MFSR34		M20x1,5	39	24	4

Końcówka przewodu pomiarowego z gwintem zewnętrznym metrycznym, DIN 3852 typ B

Male fitting

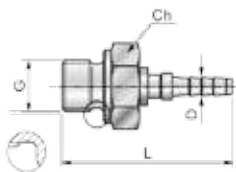

Kod / Code	Wąż / Hose	G	L	Ch	D
44MFDR00	RD2	M8x1	30	12	2
44MFDR10		M10x1	30	14	2
44MFDR30		M12x1,5	31	17	2
44MFDRM5		M5x1	30	12	2
44MFDR03	RD3	M8x1	34	12	3
44MFDR13		M10x1	34	14	3
44MFDR33		M12x1,5	35	17	3
44MFDR04	RD4	M8x1	35	12	4
44MFDR14		M10x1	35	14	4
44MFDR34		M12x1,5	36	17	4

Końcówka przewodu pomiarowego z gwintem zewnętrznym BSP, DIN 3852 typ B

Male fitting

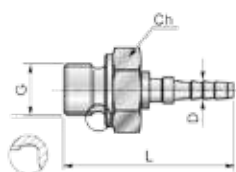

Kod / Code	Wąż / Hose	G	L	Ch	D
44MFD180	RD2	G 1/8"	28,5	14	2
44MFD140		G 1/4"	35,5	19	2
44MFD183	RD3	G 1/8"	33,5	14	3
44MFD143		G 1/4"	39	19	3
44MFD184	RD4	G 1/8"	33,5	14	4
44MFD144		G 1/4"	39	19	4

Końcówka przewodu pomiarowego AGR-K, gwint zewnętrzny BSPT stożkowy

Male fitting

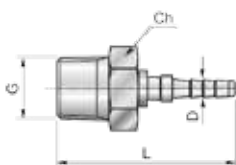

Kod / Code	Wąż / Hose	G	L	Ch	D
44MFC180	RD2	R 1/8"	28,5	12	2
44MFC140		R 1/4"	31,5	14	2
44MFC183	RD3	R 1/8"	31,5	12	3
44MFC143		R 1/4"	36,5	14	3
44MFC184	RD4	R 1/8"	31,5	12	4
44MFC144		R 1/4"	36,5	14	4

Końcówka przewodu pomiarowego AGN, gwint zewnętrzny NPTP stożkowy

Male fitting

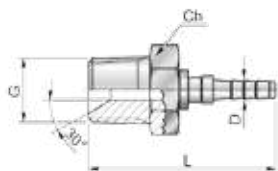

Kod / Code	Wąż / Hose	G	L	Ch	D
44MF0000	RD2	1/8"-27 NPTF	28	12	2
44MF4000		1/4"-18 NPTF	35,5	17	2
44MF8003	RD3	1/8"-27 NPTF	33	12	3
44MF0003		1/4"-18 NPTF	38	17	3
44MF8004	RD4	1/8"-27 NPTF	35	12	4
44MF0004		1/4"-18 NPTF	40,5	17	4

Końcówka przewodu pomiarowego ORFS męska

ORFS male fitting, UNF thread

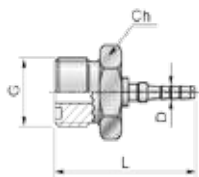

Kod / Code	Wąż / Hose	G	L	Ch	D
5991M000	RD2	9/16"-18 UNF	29	17	2
5991M003	RD3	9/16"-18 UNF	33	17	3
5991M004	RD4	9/16"-18 UNF	33	17	4

Końcówka przewodu pomiarowego AGJ, JIC stożek zewnętrzny 74°

JIC 74° male fittings

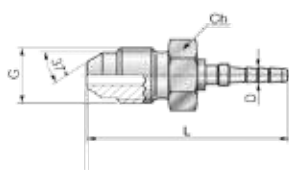

Kod / Code	Wąż / Hose	G	L	Ch	D
44AJ3800	RD2	3/8"-28 UNF	32	12	2
44AJ7100		7/16"-20 UNF	34,5	14	2
44AJ1200		1/2"-20 UNF	37	17	2
44AJ3803	RD3	3/8"-28 UNF	36	12	3
44AJ7103		7/16"-20 UNF	40	14	3
44AJ1203		1/2"-20 UNF	41	17	3
44AJ3804	RD4	3/8"-28 UNF	36	12	4
44AJ7104		7/16"-20 UNF	40	14	4
44AJ1204		1/2"-20 UNF	41	17	4

Końcówka przewodu pomiarowego wtykowa, średnica 3,3mm

Plug - in connection



Kod / Code	Wąż / Hose	L	D
33TD0000	RD2	27	2
33TD0003	RD3	31	3
33TD0004	RD4	31	4

45°

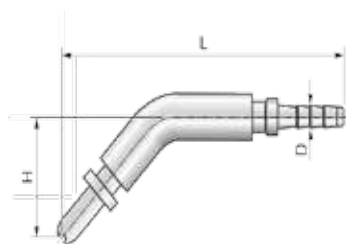

Kod / Code	Wąż / Hose	H	L	D
33TD0040	RD2	24	57	2
33TD0043	RD3	24	59	3
33TD0044	RD4	24	59	4

90°

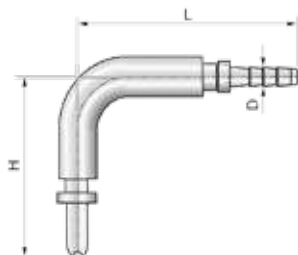

Kod / Code	Wąż / Hose	H	L	D
33TD0090	RD2	28	32	2
33TD0093	RD3	28	36	3
33TD0094	RD4	28	36	4

Końcówka przewodu pomiarowego ORFS, uszczelnienie płaskkie

ORFS female fitting, UNF thread

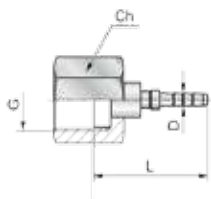

Kod / Code	Wąż / Hose	G	L	Ch	D
5991F000	RD2	9/16"-18 UNF	25	17	2
5991F003	RD3	9/16"-18 UNF	27	17	3
5991F004	RD4	9/16"-18 UNF	31	17	4

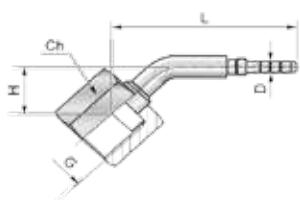

45°						
Kod / Code	Wąż / Hose	G	H	L	Ch	D
5991F040	RD2	9/16"-18 UNF	13	47	17	2
5991F043	RD3	9/16"-18 UNF	14	46	17	3
5991F044	RD4	9/16"-18 UNF	14	46	17	4

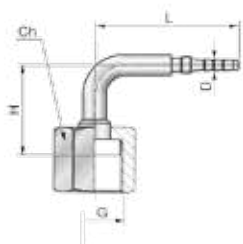

90°						
Kod / Code	Wąż / Hose	G	H	L	Ch	D
5991F090	RD2	9/16"-18 UNF	24	40	17	2
5991F093	RD3	9/16"-18 UNF	24	40	17	3
5991F094	RD4	9/16"-18 UNF	24	40	17	4

Tulejka do przewodu pomiarowego

Ferrule

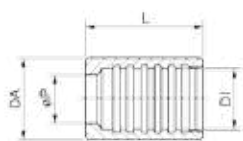

Kod / Code	DA	DI	L	ØP	Ø Press	PN [bar]
30BT2000	8	5,1	15	4,5	7,1	600
30BT2AI0*	8	5,1	15	4,5	7,1	600
30BTAI00*	8	5,7	15	4,5	7,1	600
30BT3000	9	6,5	17	6	7,6	600
30BT4000	12	9,2	17	6,5	10,2	600
30BT4AI0*	12	9,2	17	6,5	10,2	600

*Stal nierdzewna / Stainless steel

Ø Press - Średnica zakuwania / Crimping diameters

2

Zestaw pomiarowy

Modular portable pressure test kit



Kod / Code *	Nazwa / Name	Ilość / Qty. Szt. / Pcs.
EM9001A	Zawór odcinający do manometru 1/4" M-F 90° EM9001A / Gauge isolator 1/4" M-F 90° EM9001A	1
EMIL01A	Zawór odcinający do manometru 1/4" M-F linowy EMIL01A / Gauge isolator 1/4" M-F line EMIL01A	1
M63RL1/4(0-160)	Manometr glicerynowy DN63 radialny M63RL 1/4" (0-160)bar / Glycerine's pressure gauge DN63 bottom M63RL 1/4" (0-160) bar	1
M63RL1/4(0-400)	Manometr glicerynowy DN63 radialny M63RL 1/4" (0-400)bar / Glycerine's pressure gauge DN63 bottom M63RL 1/4" (0-400)bar	1
18140000	Złącze manometryczne grodziowe zewn. 1/4" BSP z wolnym przepływem / Check coupling bulkhead connection 1/4" BSP, free flow	1
20140000	Złącze manometryczne wewn. 1/4" BSP z wolnym przepływem / Pressure gauge adapter 1/4" BSP free flow	1
S10714G00C	Złącze pomiarowe gwintowane 1/4" - BSP zatyczka metalowa / Check coupling with metal cap 1/4" - BSP	1
S10738G00C	Złącze pomiarowe gwintowane 3/8" - BSP zatyczka metalowa / Check coupling with metal cap 3/8" - BSP	1
S10712G00C	Złącze pomiarowe gwintowane 1/2" - BSP zatyczka metalowa / Check coupling with metal cap 1/2" - BSP	1
S10171X20C	Złącze pomiarowe gwintowane 7/16" - 20 UNF zatyczka metalowa / Check coupling with metal cap 7/16" - 20 UNF	1
S10612X15C	Złącze pomiarowe gwintowane M12x1,5 zatyczka metalowa / Check coupling with metal cap M12x1,5	1
S10614X15C	Złącze pomiarowe gwintowane M14x1,5 zatyczka metalowa / Check coupling with metal cap M14x1,5	1
RD2-31TTN6.0-31TTN6.0-2000	Przewód pomiarowy M16x2-M16x2, L2000 / Micro hose M16x2-M16x2, L 2000	1

3

Miło nam powiadomić, że od 2010 roku zostaliśmy wyłącznym przedstawicielem w Polsce **NUOVA FIMA**, wiodącej firmy na świecie w dziedzinie pomiarów ciśnienia i temperatury.

NUOVA FIMA została utworzona w 1925 roku we Włoszech, w mieście Inverio, gdzie nadal ma umiejscowioną swoją główną produkcję. Swoje oddziały posiada również w Hiszpanii, Argentynie, Brazylii oraz Stanach Zjednoczonych, by swoją sprzedaż rozpowszechnić na różnych zakątkach świata. Zatrudnia około 230-stu bardzo dobrze wykwalifikowanych oraz zaangażowanych pracowników co owocuje ostatecznie w jakości proponowanych produktów. Stały wzrost, osiągnięcia, spełnianie wymagań technicznych, skoncentrowanie się na jakości doprowadziły, iż stała się firmą działającą zgodnie z Normami EN ISO 9001-2000.

NUOVA FIMA na swoją przyszłość patrzy bardzo optymistycznie, poprzez kierowanie swojej strategii wokół badań, wysokiej jakości, większej globalizacji oraz współpracy na rynku budowy urządzeń wiodących firm inżynieryjnych. Produkty najwyższej klasy i zastosowane procesy produkcyjne, to tylko dwa z sekretów sukcesu firmy. Producenci cenią sobie fakt, iż mogą liczyć na szeroką gamę instrumentów do pomiaru i kontroli ciśnienia.

W swojej ofercie **NUOVA FIMA** posiada: manometry, termometry, separatory, przełączniki ciśnienia, elektroniczne przetworniki ciśnienia, osłony oraz szeroki wachlarz specjalnych akcesoriów zaprojektowanych w celu wykorzystania w pełni proponowanych produktów.

*We have a pleasure to announce that since 2010 we are the exclusive distributor of **NUOVA FIMA** company, a world leader of industrial pressure and measuring instrumentation.*

***NUOVA FIMA** was set up in 1925 in Inverio, Italy, where still have its head office. Today Nuova have sales branches in Argentina, Brazil and in the USA, where almost 230 employees work to ensure top-quality products and to satisfy customer requirements. The quality of their products are guaranteed by EN ISO 9001-2000.*

*Production research and innovation have always represented one of the key factors in the success of **NUOVA FIMA**, right from the very beginning, and they will continue to do so in the future. Every years, huge amount of resources are allocated to testing new products, new materials and to improving the production process. NUOVA is ready to face the future, confident that they can provide excellent products and services.*

***NUOVA FIMA** offers: pressure gauges, thermometers, pressure switches, diaphragm seals, electronic transmitters, and many more accessories and components that can be used with their products.*





4

NUOVA FIMA

Manometr ciśnieniowy z rurką Bourdona - wersja antywibracyjna z gliceryną DS 2,5" (63 mm)

Bourdon tube pressure gauges anti-vibration version DS 2.5" (63mm)

Manometry mają zastosowanie w jednostkach energetycznych, pompach, urządzeniach myjących, prasach, sprężarkach silników, turbinach, silnikach diesla, chemicznych; petrochemicznych i chłodniczych instalacjach, maszynach i sprzętach, gdzie widoczne są ciśnienia pulsacyjne lub mechaniczne wibracje. Mogą być używane z przekaźnikami gazów lub cieczy, które nie korodują stopów miedzi, nie odznaczają się wysoką lepkością i nie krystalizują się.

Konstrukcja: EN 837-1.

Oznaczenie bezpieczeństwa: S1 jak na EN 837-2.

Zakres: od 0...15 do 0...10000 psi
(od 0...1 do 0...600 bar lub innej odpowiadającej jednostki).

Klasa dokładności: 1,6 jak na EN 837-1.

Bieg termiczny: max $\pm 0,4\%$ / 10°C zakresów
(począwszy od 20°C).

Płyn: gliceryna 98%.

Temperatura otoczenia: 0...+65°C.

Przebieg temperatury płynu: +65°C.

Ciśnienie robocze:

75% FSV dla ciśnienia statycznego;

66% FSV dla ciśnienia pulsacyjnego.

Granica zwiększonego ciśnienia (15 min max):

25% FSV dla zakresu ciśnień ≤ 1500 psi (100 bar);

15% FSV dla zakresu ciśnień powyżej 1500 psi (100 bar).

Stopień ochrony: IP 67 jak na EN 60529 / IEC 529.

Tworzywo gniazda: stop miedzi.

Rurka Bourdona: stop miedzi.

Obudowa: stal nierdzewna.

Pierścień: stal nierdzewna, polerowana, zaciskana.

Szyba: plastik.

Mechanizm: miedź, stal nierdzewna.

Tarcza: plastik, biały z czarnymi oznaczeniami.

Wskaźówka: nieregulowana, aluminiowa, czarna.

Instruments designed for use on power units, pump, hydro-cleaning machines, presses, engine compressors, turbines, diesel engines, refrigerating plants and on machines and equipment where pulsating pressures or mechanical vibrations are apparent. They can be used with gaseous or liquid media which do not corrode copper alloy and which do not have high viscosity or do not crystallize.

Design: EN 837-1.

Safety designation: S1 as per EN 837-2.

Ranges: from 0...15 to 0...10000 psi
(from 0...1 to 0...600 bar or other equivalent units).

Accuracy class: 1,6 as per EN 837-1.

Thermal drift: max $\pm 0,4\%$ / 10°C of ranges
(starting from + 68°F - 20°C).

Damping liquid: glycerine 98%.

Ambient temperature: +32...+149 °F (0...+65 °C).

Process fluid temperature: max +149°F (+65 °C).

Working pressure:

75% of FSV for static pressure;

66% of FSV for pulsating pressure.

Over pressure limit (15 min max):

25% of FSV for pressure ranges ≤ 1500 psi (100 bar);

15% of FSV for pressure ranges over 1500 psi (100 bar).

Protection degree: IP 67 as per EN 60529 / IEC 529.

Socket material: copper alloy.

Bourdon tube: copper alloy.

Case: stainless steel.

Ring: stainless steel, polished, crimped.

Window: plastic.

Movement: copper and stainless steel.

Dial: plastic, white with black markings.

Pointer: not adjustable, aluminium, black.

Montaż / Mounting	F [cale]	s [mm]	b [mm]	c [mm]	d [mm]	d ₁ [mm]	h [mm]	p [mm]	L [mm]	ch [mm]	Waga / Weight kg
z dołu / lower	G 1/4" A	5,6	28	10	68	62,6	55,3-54,3	-	13	14x9	0,20
z tyłu / back	G 1/4" A	5,6	28	-	68	62,6	-	54,8-53,8	13	14x9	0,21

Manometr ciśnieniowy z rurką Bourdona - wersja antywibracyjna z gliceryną DS 2,5" (63 mm)

Bourdon tube pressure gauges anti-vibration version DS 2.5" (63mm)

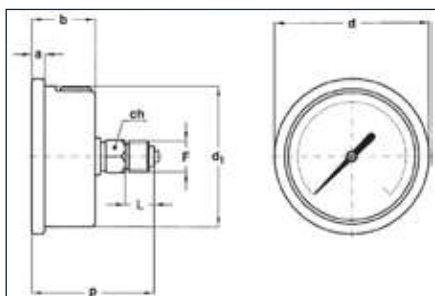
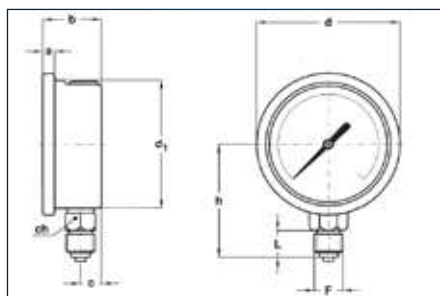

A Manometry radialne / Lower connection



D Manometry tylne centryczne / Back connection



C Manometry radialne mocowanie tablicowe / Back flange for lower connection



E Manometry tylne tablicowe / Front flange for back connection



B Manometry tylne z blaszką mocującą / "U" Clamp for back connection

Zakres ciśnienia / Pressure range	A	C	D	E	B
	Kod / Code	Kod / Code	Kod / Code	Kod / Code	Kod / Code
-1 do 0 bar	VM63RL1/4(-1-0)	VM63RL1/4(-1-0) + MTT63	VM63TL1/4(-1-0)	VM63TABL1/4(-1-0)	VM63TL1/4(-1-0) + BMT63
-1 do 1,5 bar	VM63RL1/4(-1 do +1,5)	VM63RL1/4(-1 do +1,5) + MTT63	VM63TL1/4(-1 do +1,5)	VM63TABL1/4(-1 do +1,5)	VM63TL1/4(-1 do +1,5) + BMT63
-1 do 3 bar	VM63RL1/4(-1 do +3)	VM63RL1/4(-1 do +3) + MTT63	VM63TL1/4(-1 do +3)	VM63TABL1/4(-1 do +3)	VM63TL1/4(-1 do +3) + BMT63
-1 do 5 bar	VM63RL1/4(-1 do +5)	VM63RL1/4(-1 do +5) + MTT63	VM63TL1/4(-1 do +5)	VM63TABL1/4(-1 do +5)	VM63TL1/4(-1 do +5) + BMT63
-1 do 9 bar	VM63RL1/4(-1 do +9)	VM63RL1/4(-1 do +9) + MTT63	VM63TL1/4(-1 do +9)	VM63TABL1/4(-1 do +9)	VM63TL1/4(-1 do +9) + BMT63
0 do 1 bar	M63RL1/4(0-1)	M63RL1/4(0-1) + MTT63	M63TL1/4(0-1)	M63TABL1/4(0-1)	M63TL1/4(0-1) + BMT63
0 do 2,5 bar	M63RL1/4(0-2,5)	M63RL1/4(0-2,5) + MTT63	M63TL1/4(0-2,5)	M63TABL1/4(0-2,5)	M63TL1/4(0-2,5) + BMT63
0 do 4 bar	M63RL1/4(0-4)	M63RL1/4(0-4) + MTT63	M63TL1/4(0-4)	M63TABL1/4(0-4)	M63TL1/4(0-4) + BMT63
0 do 6 bar	M63RL1/4(0-6)	M63RL1/4(0-6) + MTT63	M63TL1/4(0-6)	M63TABL1/4(0-6)	M63TL1/4(0-6) + BMT63
0 do 10 bar	M63RL1/4(0-10)	M63RL1/4(0-10) + MTT63	M63TL1/4(0-10)	M63TABL1/4(0-10)	M63TL1/4(0-10) + BMT63
0 do 16 bar	M63RL1/4(0-16)	M63RL1/4(0-16) + MTT63	M63TL1/4(0-16)	M63TABL1/4(0-16)	M63TL1/4(0-16) + BMT63
0 do 25 bar	M63RL1/4(0-25)	M63RL1/4(0-25) + MTT63	M63TL1/4(0-25)	M63TABL1/4(0-25)	M63TL1/4(0-25) + BMT63
0 do 40 bar	M63RL1/4(0-40)	M63RL1/4(0-40) + MTT63	M63TL1/4(0-40)	M63TABL1/4(0-40)	M63TL1/4(0-40) + BMT63
0 do 60 bar	M63RL1/4(0-60)	M63RL1/4(0-60) + MTT63	M63TL1/4(0-60)	M63TABL1/4(0-60)	M63TL1/4(0-60) + BMT63
0 do 100 bar	M63RL1/4(0-100)	M63RL1/4(0-100) + MTT63	M63TL1/4(0-100)	M63TABL1/4(0-100)	M63TL1/4(0-100) + BMT63
0 do 160 bar	M63RL1/4(0-160)	M63RL1/4(0-160) + MTT63	M63TL1/4(0-160)	M63TABL1/4(0-160)	M63TL1/4(0-160) + BMT63
0 do 250 bar	M63RL1/4(0-250)	M63RL1/4(0-250) + MTT63	M63TL1/4(0-250)	M63TABL1/4(0-250)	M63TL1/4(0-250) + BMT63
0 do 315 bar	M63RL1/4(0-315)	M63RL1/4(0-315) + MTT63	M63TL1/4(0-315)	M63TABL1/4(0-315)	M63TL1/4(0-315) + BMT63
0 do 400 bar	M63RL1/4(0-400)	M63RL1/4(0-400) + MTT63	M63TL1/4(0-400)	M63TABL1/4(0-400)	M63TL1/4(0-400) + BMT63
0 do 600 bar	M63RL1/4(0-600)	M63RL1/4(0-600) + MTT63	M63TL1/4(0-600)	M63TABL1/4(0-600)	M63TL1/4(0-600) + BMT63
0 do 1000 bar	M63RL1/4(0-1000)	M63RL1/4(0-1000) + MTT63	M63TL1/4(0-1000)	*	M63TL1/4(0-1000) + BMT63



Manometr ciśnieniowy z rurką Bourdona - wersja ciężka antywibracyjna DS 4" (100mm)

Bourdon tube pressure gauges anti-vibration heavy duty version DS 4" (100mm)

Manometry mają zastosowanie w pompach, jednostkach energetycznych, urządzeniach myjących, prasach, turbinach, sprężarkach silników, silnikach diesla, chemicznych; petrochemicznych i chłodniczych instalacjach, maszynach i sprzętach, gdzie widoczne są ciśnienia pulsacyjne lub mechaniczne wibracje. Mogą być używane z przekaźnikami gazów lub cieczy, które nie korodują stopów miedzi, nie odznaczają się wysoką lepkością i nie krystalizują się.

Konstrukcja: EN 837-1.

Oznaczenie bezpieczeństwa: S1 jak na EN 837-2.

Zakres: od 0...15 do 0...15000 PSI

(od 0...1 do 0...1000 bar lub innej odpowiadającej jednostki).

Klasa dokładności: 1,6 jak na EN 837-1.

Temperatura otoczenia: +15...+65°C.

Bieg termiczny: max ±0,4% / 10K zakresu

(zaczynając od 20°C).

Płyn: gliceryna 98%, olej silikonowy, fluorowany płyn.

Przebieg temperatury płynu: max +65°C.

Ciśnienie robocze:

75% FSV dla ciśnienia statycznego;

66% FSV dla ciśnienia pulsacyjnego.

Granica zwiększonego ciśnienia (max 15 min):

25% FSV dla zakresu ciśnień ≤ 1500 psi (100 bar);

15% FSV dla zakresu ciśnień powyżej 1500 psi (100 bar).

Stopień ochrony: IP 67 jak na IEC 529.

Tworzywo gniazda:

stop miedzi z wewnętrznym ogranicznikiem Ø 0.03" (0,8 mm).

Rurka Bourdona:

stop miedzi dla zakresów ≤ 600 bar;

AISI 316L st. st. dla zakresów > 1000 bar.

Obudowa: stal nierdzewna.

Pierścień: stal nierdzewna, polerowana, zaciskana.

Szyba: szkło hartowane.

Mechanizm: miedź i stal nierdzewna.

Tarcza: aluminium, biała z czarnymi oznaczeniami.

Wskazówka: nieregulowana, aluminiowa, czarna.

Instruments designed for use on power units, pumps, hydro-cleaning machines, presses, engine compressors, turbines, diesel engines, chemical, petrochemical and refrigerating plants and on machines and equipment where pulsating pressures or mechanical vibrations are apparent. They can be used with gaseous or liquid media which do not corrode copper alloy and which do not have high viscosity or do not crystallize.

Design: EN 837-1.

Safety designation: S1 as per EN 837-2.

Ranges: from 0...15 to 0...15000 PSI

(from 0...1 to 0...1000 bar or other equivalent units).

Accuracy class: 1,6 as per EN 837-1.

Ambient temperature: +59...+149 °F with glycerine filling.

Thermal drift: ±0,4 %/10 K of ranges

(starting from 68°F - 20°C).

Damping liquid: glycerine 98%, silicon oil or fluorinated fluid.

Process fluid temperature: max +149°F (+65 °C).

Working pressure:

75% of FSV for static pressure;

66% of FSV for pulsating pressure.

Overpressure limit (max 15 min):

25% of FSV for pressure ranges ≤ 1500 psi (100 bar);

15% of FSV for pressure ranges over 1500 psi (100 bar).

Protection degree: IP 67 as per IEC 529.

Socket material:

copper alloy with internal restrictor Ø 0.03" (0,8 mm).

Bourdon tube:

copper alloy for ranges ≤ 10000 psi (600 bar);

AISI 316L st.st. for ranges > 15000 psi (1000 bar).

Case: stainless steel.

Ring: stainless steel, polished, crimped.

Window: tempered glass.

Movement: copper and stainless steel.

Dial: aluminium, white with black markings.

Pointer: not adjustable, aluminium, black.

Montaż / Mounting	F	s	b	c	d	d ₁	e	h	p	L	ch	Waga / Weight
	[cale]	[mm]	[mm]	[mm]	[mm]	[mm]	[mm]	[mm]	[mm]	[mm]	[mm]	kg
z dołu / lower	G 1/2" A	13	48,6	16,1	110,6	101	-	86	-	20	22	0,85
z tyłu / back	G 1/2" A	13	48,6	-	110,6	101	31	-	86,8	20	22	0,90

Manometr ciśnieniowy z rurką Bourdona - wersja ciężka antywibracyjna DS 4" (100mm)

Bourdon tube pressure gauges anti-vibration heavy duty version DS 4" (100mm)

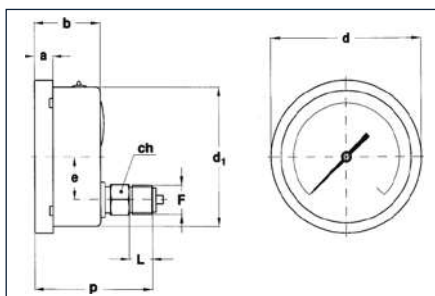
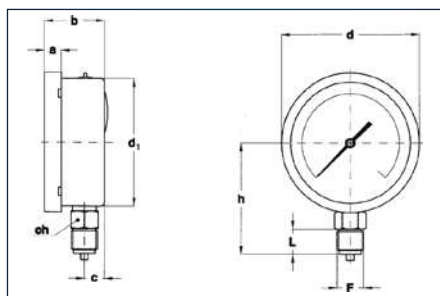

A Manometry radialne /
Lower connection



D-EX Manometry tylne ekscentryczne /
Back connection excentric

Opcje / Options



C Manometry radialne mocowanie tablicowe /
Back flange for lower connection



E Manometry tylne tablicowe /
Front flange for back connection



B Manometry tylne z blaszką mocującą /
"U" Clamp for back connection

Zakres ciśnienia / Pressure range	A	D-EX
	Kod / Code	Kod / Code
-1 do 0 bar	VM100RL1/2(-1-0)	VM100TL1/2(-1-0) EKS
-1 do 1,5 bar	VM100RL1/2(-1 do +1,5)	VM100TL1/2(-1-+1,5) EKS
-1 do 3 bar	VM100RL1/2(-1 do +3)	VM100TL1/2(-1-+3) EKS
-1 do 5 bar	VM100RL1/2(-1 do +5)	VM100TL1/2(-1-+5) EKS
-1 do 9 bar	VM100RL1/2(-1 do +9)	VM100TL1/2(-1-+9) EKS
0 do 1 bar	M100RL1/2(0-1)	M100TL1/2(0-1) EKS
0 do 2,5 bar	M100RL1/2(0-2,5)	M100TL1/2(0-2,5) EKS
0 do 4 bar	M100RL1/2(0-4)	M100TL1/2(0-4) EKS
0 do 6 bar	M100RL1/2(0-6)	M100TL1/2(0-6) EKS
0 do 10 bar	M100RL1/2(0-10)	M100TL1/2(0-10) EKS
0 do 16 bar	M100RL1/2(0-16)	M100TL1/2(0-16) EKS
0 do 25 bar	M100RL1/2(0-25)	M100TL1/2(0-25) EKS
0 do 40 bar	M100RL1/2(0-40)	M100TL1/2(0-40) EKS
0 do 60 bar	M100RL1/2(0-60)	M100TL1/2(0-60) EKS
0 do 100 bar	M100RL1/2(0-100)	M100TL1/2(0-100) EKS
0 do 160 bar	M100RL1/2(0-160)	M100TL1/2(0-160) EKS
0 do 250 bar	M100RL1/2(0-250)	M100TL1/2(0-250) EKS
0 do 300 bar	M100RL1/2(0-300)	M100TL1/2(0-300) EKS
0 do 315 bar	M100RL1/2(0-315)	M100TL1/2(0-315) EKS
0 do 400 bar	M100RL1/2(0-400)	M100TL1/2(0-400) EKS
0 do 600 bar	M100RL1/2(0-600)	M100TL1/2(0-600) EKS
0 do 1000 bar	M100RL1/2(0-1000)	M100TL1/2(0-1000) EKS
0 do 2000 bar	M100RL1/2(0-2000)	*
0 do 2500 bar	M100RL9/16-18 UNF(0-2500)	*
0 do 3000 bar	M100RL9/16-18 UNF(0-3000)	*
0 do 4000 bar	M100RL9/16-18 UNF(0-4000)	*

4

Manometr ciśnieniowy (40/50 mm)

Pressure gauge (40/50mm)

Oferujemy również bezpośrednio z magazynu manometry mniej standardowe:

- Średnica DN40
- Średnica DN50
- Z gwintami metrycznymi

Sprowadzamy w krótkim terminie szeroką gamę manometrów o zastosowaniach przemysłowych m.in. do przemysłu wydobywczego, rafinerii, przemysłu spożywczego, elektrowni, laboratoriów. Gwarantujemy najwyższą jakość i niski poziom cen.

W celu sprawdzenia dostępności konkretnych średnic prosimy o kontakt z Działem Handlowym.

Manometr ciśnieniowy M40 (40mm)

Pressure gauge M40 (40mm)

- A** Manometry radialne / Lower connection **D** Manometry tylne centryczne / Back connection



Zakres ciśnienia / Pressure range	A	D
	Kod / Code	Kod / Code
0 do 25 bar	M40RL1/8(0-25)	*
0 do 100 bar	M40RL1/8(0-100)	*
0 do 160 bar	M40RL1/8(0-160)	M40TL1/8(0-160)
0 do 250 bar	M40RL1/8(0-250)	M40TL1/8(0-250)
0 do 315 bar	*	M40TL1/8(0-315)
0 do 400 bar	*	M40TL1/8(0-400)

Dostępne bezpośrednio z magazynu / Available from stock

Manometr ciśnieniowy M50 (50mm)

Pressure gauge M50 (50mm)

- A** Manometry radialne / Lower connection **D** Manometry tylne centryczne / Back connection



Zakres ciśnienia / Pressure range	A	D
	Kod / Code	Kod / Code
0 do 6 bar	*	M50TL1/4(0-6)
0 do 10 bar	M50RL1/4(0-10)	M50TL1/4(0-10)
0 do 16 bar	M50RL1/4(0-16)	*
0 do 25 bar	M50RL1/4(0-25)	M50TL1/4(0-25)
0 do 100 bar	M50RL1/4(0-100)	M50TL1/4(0-100)
0 do 160 bar	M50RL1/4(0-160)	M50TL1/4(0-160)
0 do 250 bar	M50RL1/4(0-250)	M50TL1/4(0-250)
0 do 315 bar	M50RL1/4(0-315)	M50TL1/4(0-315)
0 do 400 bar	M50RL1/4(0-400)	M50TL1/4(0-400)

Dostępne bezpośrednio z magazynu / Available from stock

101 SERIES – BOURDON TUBE PRESSURE GAUGE



101A



101B



101F

Description

101 series is filled with glycerine which are used to resist vibration and pulsation, Instruments can be used with gaseous or liquid media which do not corrode copper alloy and which do not have high viscosity or do not cristalize.

Material Feature

CASE	SS304, Polished
RING	SS304, Polished
WINDOW	Polycarbonate or Tempered Glass
DIAL	Aluminium
POINTER	Aluminium
ACCURACY	1.6%

CONNECTION	Brass / BSP
THREAD SIZE	1/4", 1/2"
CONNECTION TYPE	2 Parts
MOVEMENT	Brass
BOURDON TUBE	Phosphorus Bronze
PRESSURE RANGE	0-1000 bar

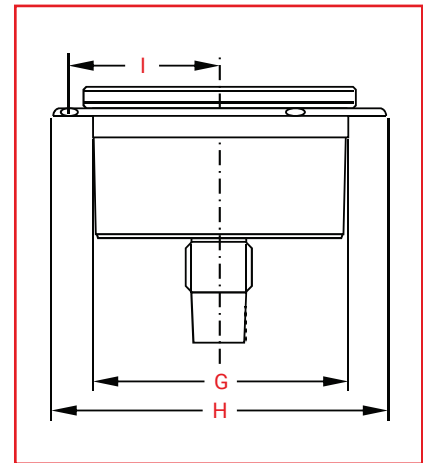
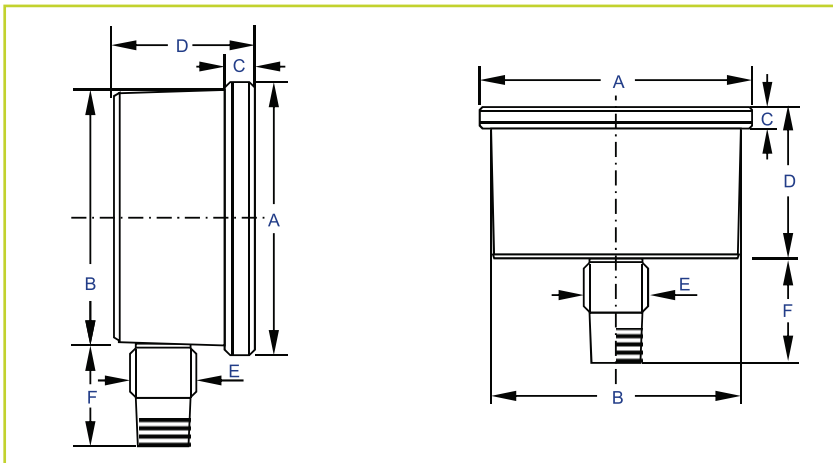

Dimensions

CODE	DIA(mm)	SIZE								
		A	B	C	D	E	F	G	H	I
C101	63	68.0	61.0	6.0	29.0	14.0	24.0	63.0	84.0	37.0
G101	100	108.5	98.5	9.0	37.5	22.0	36.0	99.5	130.0	58.5



PED 2014/68/EU

Zawory odcinające do manometrów - liniowy EM IL - kątowy 90° EM 90

Gauge isolators - line type EM IL - 90° type



Kod / Code	Gwint / Thread	Oznaczenie / Signature
EMIL01A	G 1/4"	Liniowy / Line M-F
EMIL01B	G 1/4"	Liniowy / Line F-F
EMIL01C	G 1/4"	Liniowy / Line F-FG
EM9001A	G 1/4"	Kątowy 90° M-F
EM9001B	G 1/4"	Kątowy 90° F-F
EM9001C	G 1/4"	Kątowy 90° F-FG

Złączki pośrednie

Connectors



Kod / Code	Przylączka / Adapters	
	Gwint wew. / Female thread	Gwintzew. / Male thread
MAKZLA 001	G 1/4"	M12x1,5
MAKZLA 002	G 1/2"	M20x1,5
MAKZLA 003	M12x1,5	G 1/4"
MAKZLA 004	M20x1,5	G 1/2"
MRD 105.02	1/4"	1/4"
MRD 105.03	1/2"	1/2"

Mocowania

Brackets



Typ / Type	Ø manometru / Ø pressure gauges
Błazka mocująca BMT 63 / Bracket BMT 63	63 mm

Kołnierz PCV

Cover flanges



Typ osłony / Cover type	Ø manometru / Ø pressure gauges	Kolor / colour
Kołnierz gumowy Rubber flange	63mm	czarny black
Kołnierz gumowy Rubber flange		czerwony red
Kołnierz gumowy Rubber flange	63mm	niebieski blue
Kołnierz plastikowy Plastic flange		czarny black
Kołnierz gumowy Rubber flange	100mm	czarny black
Kołnierz plastikowy Plastic flange		czarny black

Zakuwarka ręczna SWHM10 / SWHP10

Handypress SWHM10/SWHP10

Uniwersalna zakuwarka hydrauliczna przeznaczona do napraw oraz krótkich serii produkcyjnych przewodów klimatyzacyjnych, a także przewodów o niskim i średnim ciśnieniu w układach pneumatycznych i hydraulicznych. Prasa składa się z dwóch zintegrowanych elementów: podwójnej głowicy do zaciskania oraz dźwigni pompy ręcznej.

Nowy 8 szczękowy system zaciskania promieniowego pozwala na bezpieczne zakuwanie z możliwością regulacji średnicy na całym obwodzie tulejki. Optyczna kontrola średnicy zacisku zapewniona jest poprzez naklejony piktogram oraz specjalne urządzenie elektroniczne z wielokolorową diodą LED (opcjonalnie), które mierzy wysuw tłoków. Wymiana szczęk jest szybka i łatwa dzięki specjalnemu narzędziu, które dostarczone jest wraz z prasą.

Głowica pompy posiada obrotowe o 360° złącze, które czyni narzędzie łatwym do pracy w każdych warunkach. Pompa wyposażona jest w znaki bezpieczeństwa oraz przebadane w 100% zawory skonstruowane ze stali AISI 303 odpornej na korozję. Jednostka jest dostarczona wraz z zaworem, który automatycznie usuwa nadmiar oleju z układu do zbiornika wewnętrznego chroniąc narzędzie przed zbędnym działaniem.

Handypress is a universal hydraulic crimper designer for repairing and small series production of hoses for A/C&R systems and low and medium pressure pneumatic and hydraulic circuits. The tool is composed of two integrated hydraulic units: a dual cylinder and lever hand pump.

The new 8-die radial crimping system makes it possible to carry out crimping with adjustable diameter, safe and uniform on the circumference of the ferrule. Visual control of the crimping diameter is guaranteed by an adhesive pictogram label and by an exclusive electronic device with multicolour LEDs (optional) that measures the stroke of the pistons. Die changing is quick and easy thanks to the exclusive tool provided.

The pump head is composed of a 360° swivel coupling, with makes the tool easy to handle in any working condition. The pump is equipped with safety screens and 100% tested valves constructed in AISI 303 steel so they are resistant to corrosion. The units is provided with a safety valve that automatically discharges to excess oil into the internal reservoir, protecting the tool from unnecessary stress.



SWHM10

SWHM10 Super lekkie i kompaktowe narzędzie, które za pomocą pompki ręcznej jest w stanie bezpiecznie zakuwać niemal wszędzie, także w miejscach bez dostępu do jakiegokolwiek źródła energii.

SWHP10 Dzięki hydraulicznemu przedłużeniu za pomocą szybkozłączki można z łatwością pracować zarówno w warsztacie, jak i w samochodzie.



SWHP10

SWHM10 Ultralight and compact tool able to ensure with just a few pumping a safety crimping operation anywhere and in places far away from energy sources.

SWHP10 Thanks to the quick fittings and the hydraulic extension you can work easily everywhere, on the bench or on the vehicle.

Zakuwarka ręczna SWHM10 / SWHP10

Handypress SWHM10/SWHP10



Dane techniczne / Technical data	Wymiary / Dimensions
Długość / Length	412 mm
Szerokość / Width	146 mm
Grubość / Thickness	30 - 46 mm
Max. otwarcie głowicy / Max. die opening	10 mm*
Siła zacisku / Force	100kN a 70 MPa
Waga / Weight	4,2 kg
Pompa / pump	
Ilość cykli pompy do osiągnięcia średnicy zakucia / Number of pumping to reach the crimp diameter	43 - 49
Maksymalna siła na dźwigni / Max. force on the lever	25 kg
Kalibracja nastawy zaworu przeciążeniowego / Pressure relief valve calibration	55 MPa ± 5%

*Średnica standardowej szczęki / nominal diameter of die

Funkcje:

Zakuwarka została zaprojektowana według najwyższych standardów technologii produkcyjnej opartych na rekomendacjach profesjonalnych serwisów. Dzięki doświadczeniu, technologii oraz wiedzy technicznej zostało stworzone niezawodne i dokładne narzędzie do zakuwania, którym można pracować w każdym miejscu.

Sprawdź co ma do zaoferowania:

- Zaciskanie promieniowe (8 szczęk)
- Regulowana średnica zaciskania
- Elektroniczny miernik średnicy zaciskania
- Ruchoma głowica zakuwarki
- Wygodny system otwierania i zamykania głowicy
- Ergonomiczna obudowa
- Wytrzymała budowa
- Dogodna wymiana szczęk
- Obrotowa głowica 360°
- Wbudowany zawór bezpieczeństwa

Features:

Handypress is designed using the state-of-the-art manufacturing technology and based on recommendations from service professionals. Experience, technology and feedback are converted into a reliable and accurate crimping tool easy to work anywhere.

Discover what handypress has to offer:

- 8-die radial crimp
- Adjustable crimp diameter
- Crimp diameter electronic meter
- Removable crimper top
- Snap open-close system
- Ergonomic cover
- Heavy duty construction
- Easy-change dies
- 360° swivel pump provision
- Built-in safety valve



HYDRO

Napędzamy Twoje możliwości



Korzyści współpracy:

- ▶ E-sklep www.B2B.hydro.pl - łatwość składania zamówień
- ▶ 90% produktów dostępnych „od ręki” bezpośrednio z magazynu
- ▶ **Szeroka oferta** produkowanych elementów systemów i hydrauliki siłowej
- ▶ 95% zamówień **realizowanych tego samego dnia**
- ▶ **Doradztwo techniczne** i własny dział konstrukcyjny
- ▶ Zaufany **partner** i wieloletnia współpraca z europejskimi dostawcami
- ▶ Konkurencyjne ceny dzięki pozycji **lidera hydrauliki siłowej** w Polsce
- ▶ Pełna **dokumentacja techniczna** produktów
- ▶ Sprawny serwis i obsługa gwarancyjna
- ▶ Możliwości **technologiczne i logistyczne**
- ▶ Profesjonalizm, **dbałość o klienta** - ponad 35 lat w branży hydrauliki siłowej



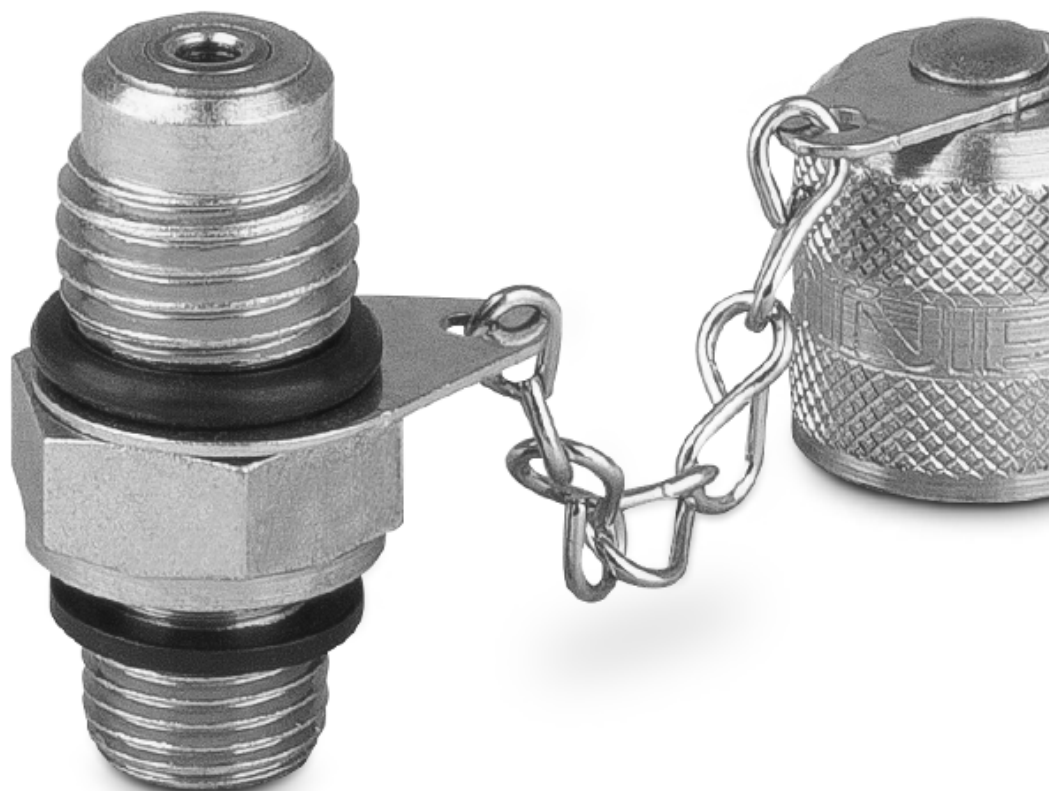

HYDRO ZNPHS Sp. z o.o.

ul. Strażacka 60

43-382 Bielsko-Biała, Polska

NIP PL 5470170044

hydro.pl • b2b.hydro.pl

Oddział handlowy

ul. Świt 37

43-382 Bielsko-Biała, Polska

+48 33 829 56 87